

Nevada Gold™ Pull Tab Dispensing Machine

Operator's Manual

For All Cash Accepting Models

**Arrow International, Inc.
Capitol Bingo Equipment Division
Arrow Games (Canada)**



Updated October 1, 2009

Information in this document pertains to this release of the Arrow International, Inc. Nevada Gold™ Pull Tab Dispenser. Modifications are periodically made to the information: any such changes will be reported in subsequent revisions.

The laws that determine the legality of this product change constantly. It is the responsibility of the buyer to determine which products are legal in any given area.

This device is protected by a published international patent application P.C.T. (Patent Co-Operation Treaty) # PCT/CA97/00618

©Copyright Arrow International, Inc. 1998

All trademarks, trade names, and patents are the property of their respective companies.



Arrow Technical Assistance Center

*Protecting Your Investment Through
Innovative Solutions and Support*

Phone Support Hours: 8:00 AM to 12:00 AM

800-277-6214

www.arrowinternational.com

INTRODUCTION

Your new Capitol Nevada Gold™ Pull Tab Dispenser is designed using state of the art technology. Its rugged all steel construction, modular design and exceptional user convenience set it apart from the competition. Benefits include: accurate sales recording, complete security, reduced staff requirements, high speed dispensing and the capability to play a variety of tickets.

The Nevada Gold™ Pull Tab Dispenser features 1000 ticket capacity per column and vends one, three, four, five or six window tickets.

The bill validator accepts \$1.00, \$5.00, \$10.00 and \$20.00 denominations and holds a maximum of 600 bills. The coin acceptor (if installed) accepts 25 cent & \$1.00 coins in the United States and 25 cent, \$1.00 and \$2.00 coins in Canada. Your Nevada Gold™ Pull Tab Dispenser is capable of tickets that sell for \$0.10, \$0.25, \$0.50, \$1.00, \$2.00 or \$5.00 denominations.

A “Play All” button enables to user to play all existing credits from any one column up to a maximum of 100 tickets.

The Nevada Gold™ Pull Tab Dispenser offers quick front loading of tickets, and individual modular ticket columns that may be easily removed for service without affecting the operation of other columns.

Security features include: separate keys for tickets and money, an alarm to prevent unauthorized access and theft and on random select models and models with the printer update kit installed automatic date and time tracking of the last 30 door openings.

Cash totals and sales totals are stored in both resettable and non-resettable electronic memory and are backed up by non-resettable electro-mechanical meters. The electronic memory will hold even when power has been disconnected.

An optional printer upgrade kit allows a single printer to generate hard copy reports of accounting information for any number of dispensers.

The Nevada Gold™ Pull Tab Dispenser offers many years of trouble-free service. However, should a problem arise, our service department will provide timely response on repairs, spare parts and technical support.

DAMAGE ACTION PROCESS

Your Capitol Bingo Equipment contains delicate electronic equipment. It is imperative that you thoroughly inspect the contents of the package before accepting product delivery from the carrier.

In case of severe damage, refuse the equipment from the carrier. Contact your local Arrow International distributor for immediate replacement.

If the product is damaged but acceptable, make a note on the bill of lading before accepting. Take a photo of the damage before and after unpacking as a record of claim against the carrier. Contact the carrier's agent immediately for inspection. Be sure to obtain a copy of the inspection report for your records.

If these precautions are not taken, we cannot assist you in recovering the amount of the claim against the carrier.

TABLE OF CONTENTS

INTRODUCTION.....	1
DAMAGE ACTION PROCESS	2
OVERVIEW.....	5
What You Should Know	5
Important Safety Information	6
Unpacking.....	6
Check Your Shipment.....	7
INSTALLATION	9
Choosing A Location	9
Wall-Mounting the Unit	10
Surface Mounting the Unit.....	10
Opening the Cabinet Doors.....	10
Connecting the Battery.....	11
Disconnecting the Battery	11
About the Alarm.....	12
PREPARATION	13
Turning On the Unit.....	13
Turning Off the Unit	14
Loading Tickets	14
Removing Tickets.....	17
Displaying Sample Tickets	17
BASIC OPERATION	18
Accessing Menus.....	18
Managing PIN Numbers.....	19
Tracking Sales.....	20
Establishing Column Ticket Pricing	22
Testing the Dispensing Unit	23
Setting the Date and Time.....	24
Tracking Door Openings.....	26
Reading the Dispenser's Serial Number.....	27

TABLE OF CONTENTS

Clearing Established Credits.....	27
Resetting Error Messages	27
Emptying the Cash.....	30
OPTIONAL VIDEO DISPLAY	32
Video Display Settings.....	33
System Settings.....	35
Images.....	36
Display Configuration.....	37
OPTIONAL REPORT PRINTER	40
Generating the Report	40
PLAYER INFORMATION.....	43
Dispensing Tickets	43
CARE AND MAINTENANCE	45
Lubricating the Chute Door.....	45
Lubricating the Accelerator Roller Shafts.....	46
Cleaning the Infrared Sensor	46
Cleaning the Bill Validator.....	47
Cleaning the Coin Acceptor.....	47
Clearing Jammed Bills.....	48
Replacing a Ticket Column.....	48
Adjusting for Different Ticket Thickness	49
RANDOM NUMBER GENERATION.....	51
Optional Random Ticket Dispense.....	51
TROUBLESHOOTING	52
Bill Validator Diagnostics.....	56
SPECIFICATIONS.....	58
CAPITOL BINGO EQUIPMENT LIMITED WARRANTY.....	59

OVERVIEW

Read this manual completely before you begin. The information provided in this document describes the procedures required for successful operation of this unit.

Throughout this manual, you will see . Pay particular attention to these sections. If you do not follow the instructions correctly, you may adversely affect the operation of your dispenser.

What You Should Know

Before you begin, familiarize yourself with the information in this manual and your model of Nevada Gold™ Pull Tab Dispenser. Note the following important details:

- The keypad located inside the model is used to maintain the unit.
- You must have a valid Personal Identification Number (PIN) to maintain the unit.
- You should not share your PIN number with others.
- Players cannot dispense tickets if the machine door is unlocked.
- The Nevada Gold™ Pull Tab Dispenser accepts cash from 25 cent coins to \$20.00 bills, depending upon the model of your machine.
- Players cannot enter money when a credit of greater than \$80.00 has been established. The green light on the bill collector turns red and no currency is accepted.
- When the player presses the PLAY ALL button and then presses a column button, up to 100 tickets dispense at the column price selected and the remaining credits are displayed. If the price per ticket in the column selected is not evenly divisible by the credits entered, a credit displays after the tickets are dispensed. Enter more money to dispense a ticket for a credit that does not equal the cost of tickets in the machine. For example, if a \$5.00 credit appears in a machine containing only \$2.00 tickets, two \$2.00 tickets dispense and a \$1.00 credit appears. Another \$1.00 is required to dispense the remaining ticket.

- Pressing only one column button allows players to dispense one ticket at a time.
- After each ticket is vended, the remaining credit amount displays on the LCD.
- The bill collector indicator turns green and accepts money once the credits are reduced to \$80.00 or less.
- If you have any questions, contact your Arrow distributor or Arrow International for assistance.

Important Safety Information



Some caution must be exercised when using the Nevada Gold™ pull tab dispenser. Be sure to read and understand the following important information to ensure safe and prolonged operation of the unit:

- Do not install or use the machine near water or moisture. Take care not to spill any liquids on the machine.
- Do not use any abrasive materials or solvents to clean the machine.
- Do not drop retaining plates in between the ticket columns when removing. A short circuit could result, causing serious damage to the product.
- Do not spill oil on the rubber surfaces of the rollers when lubricating.
- Do not use a metal crevice tool to vacuum the inside of the unit unless the power is off.
- Use a plastic crevice tool to vacuum inside the unit when the machine is plugged in.
- Use a soft damp cloth with a drop of liquid fabric softener to clean the glass on the unit.
- Use any light lubricant in a precision oiling tool to lubricate the rollers, transfer bottom shaft and the chute door.

Unpacking

To unpack your dispenser, set box upright on a firm level surface. Cut the shipping straps and lift off the top and remove packaging material. Now the dispenser can be moved from the bottom carton to the permanent location.

Take note of the keys and the manual to keep in a safe place.

In order to protect the columns and main door glass during shipping, the adjustable backs of the columns have been taped in place. You should remove the tape before using your dispenser so that you can properly adjust the columns for different ticket lengths. Unlock the main door with the key supplied, and carefully peel off the tape on the side of each column.

Also, remove the cardboard packing from the bill acceptor bill box and remove the cardboard strip from the bill pathway before use.

Whether you wall mount or surface mount the dispenser, keep in mind that a 4-column unit weighs 145 pounds, and an 8-column unit weighs 225 pounds. Use care and get assistance before unpacking and lifting. A minimum of two people are required.

Check Your Shipment

Ensure that your shipment contains the following:

- The correct model of the Nevada Gold™ Pull Tab Dispenser which you have ordered
- Power supply for ticket dispenser
- Two keys to open the cabinet doors
- Two keys to open the bill acceptor and coin collectors (coin collectors are available on selected models only)
- One H-shaped retaining plate per dispensing column
- Leveling feet (you receive four leveling feet with a four column dispenser and eight leveling feet with an eight column dispenser)
- Coin box (if your dispenser is equipped with a coin collector)

Contact your local Arrow Distributor if you do not have any of the above items.

NOTE:

In order to validate your warranty, you must present proof of purchase to Arrow International.

Keep a sales receipt or invoice to protect your investment.

**** See pages 59-60 for more details ****



Arrow Technical Assistance Center
*Protecting Your Investment Through
Innovative Solutions and Support*

Phone Support Hours: 8:00 AM to 12:00 AM
800-277-6214
www.arrowinternational.com

INSTALLATION

Choosing a Location

Before using your Nevada Gold™ Pull Tab Dispenser, you must ensure that it is properly installed and ready for use. It is important that you position the unit in a safe and secure location. Make sure that your location:

- Provides accessibility to an electrical outlet to plug in the unit
- Remains dry
- Allows the user to reach the unit when selecting the wall-mounting option
- Provides a level surface on which to place the unit when choosing to operate the unit from a table, counter or shelf
- Provides ample room for both the upper and lower cabinet doors to swing open to the left, to the right, or both

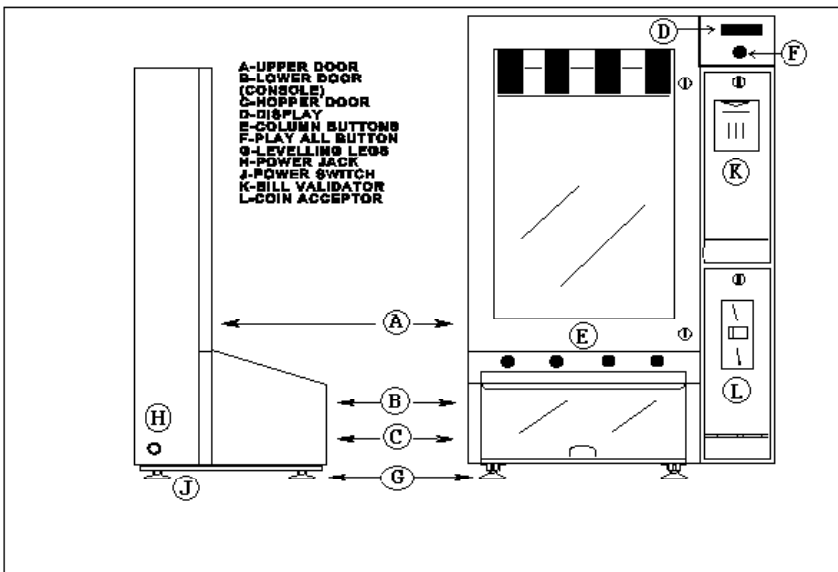

Wall-Mounting the Unit

If you decide to wall-mount the unit, choose a location that allows you to open both the upper and lower cabinet doors after the unit has been mounted. Note that each four-column model weighs approximately 145 pounds before any tickets are loaded. Keep this in mind when deciding where to mount the unit. Also, consider that the height of individual users varies when deciding how high to place the unit.

The unit is designed for wall-mounting based on a 16 inch stud spacing (4 column machine). This requires four 5/16 inch diameter lag bolts (or a bolt to fit your wall application) and a socket wrench with extension. Open the cabinet doors. Insert the lag bolts through the mounting eyes in the back of the unit and secure the bolts into the wall.

Surface Mounting the Unit

The dispenser is easily installed on a level surface like a table, counter or shelf. If your surface is not completely level, you can adjust the unit using the leveling feet provided. The leveling feet also protect the surface on which you mount the unit.

Secure the unit to its location using lag bolts or nuts and bolts. Each leg contains a hole designed to allow you to secure the unit in place with a 5/16 inch bolt.

Opening the Cabinet Doors

The upper cabinet door contains two locks for security. You must unlock the upper door before opening the lower cabinet door. To open the lower cabinet door, release the lever on the latch located just above the lower cabinet door.

The unit appears as follows:

- A- Display Rack
- B- Column
- C- Cash & Ticket Meters
- D- Console Latch
- E- Mounting Eye
- F- Keypad

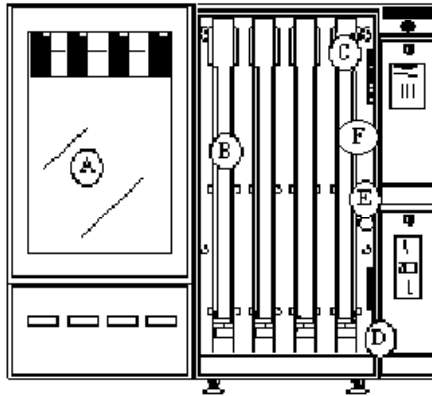

Connecting the Battery

When you first receive your Nevada Gold™ Pull Tab Dispenser, connect the battery inside the unit. Also, connect the battery if it is disconnected.

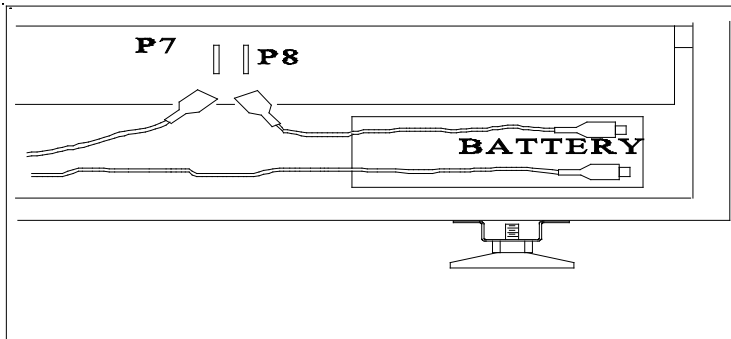

Plug in the two connectors as illustrated. The display on the console will now read ALARM ACTIVATED ENTER PIN NUMBER.

Disconnecting the Battery

You must disconnect the battery if you are shipping the unit or if the AC power will be shut down for more than 96 hours. Disconnect the battery and tape the connectors to insulate the ends and prevent accidental short circuits.



About the Alarm

The Nevada Gold™ Pull Tab Dispenser is fully alarmed to prevent unauthorized access to the machine and theft.

The alarm operates on a seven second delay and sounds under the following conditions:

- Any door is opened
- The AC power is disconnected

Note that on the initial power up of the dispenser, the alarm may also sound.

To clear an alarm, open the cabinet door and enter your four digit PIN number.

NOTE: If you do not wish to have the alarm sound during a power failure, you should not connect the battery inside the unit. By doing this, however, the alarm will not sound during a theft of the machine, and if a player has credits established when the power fails, the player will not be able to continue playing until power to the dispenser is restored. If you choose to do this, make sure that you tape the battery connectors to insulate the ends and prevent accidental short circuits.

PREPARATION

Turning on the Unit

Once the machine is safely secured to a surface and the battery is connected:



1. Attach the power supply connector to the left side of the machine. This connector only fits in one way: do not use force. Plug in the power supply (plug) to a 120V outlet. It is recommended that you plug your dispensing machine into a surge-protected circuit or use a good quality surge-protected power bar.
2. Press the On/Off switch located under the unit on the left-hand side. (The LCD backlighting and the interior cabinet lighting will turn on when the unit is switched on.)
3. Unlock and open the cabinet doors.
4. If this is the first time you are using the dispenser, and the unit either has the optional printer upgrade kit installed or is a random column select dispenser, the LCD will prompt you to enter the date and time. See page 24 for instructions on setting the date and time. The dispenser will also prompt you to enter the date and time after all power has been disconnected from the unit and then reconnected.
5. The LCD will now appear as follows:



6. Enter your four digit PIN number.

Note that the Nevada Gold™ Pull Tab Dispenser is pre-programmed with PIN number 1000 in position #5.



If this is the first time you are using the dispenser, you must set the column ticket prices before you can dispense tickets. If you lock the cabinet door before establishing ticket prices, the LCD displays the following:



You must unlock the cabinet door and set the ticket pricing. See page 22 for details.

If the cabinet door is locked and ticket pricing is set, players can purchase tickets.

Turning Off the Unit

Use the On/Off switch located on the bottom left corner of the machine to turn off the unit. Turning off the unit does not affect any of the column price settings, electronic totals or PIN number entries, nor does turning off the unit affect the battery backup. If you are going to store the machine for more than 96 hours, disconnect the battery (see page 11).

Loading Tickets

The Nevada Gold™ Pull Tab Dispensers can be adapted to fit one window, three window, four window, five window and six window ticket types, where approved by the government. The tickets vary in size. You can adjust each column to the appropriate ticket size and load up to 1000 tickets per column.

-- WARNING --

For optimum performance it is highly recommended that only tickets manufactured by Arrow International, Inc. be used in this machine.

Arrow International will not warranty problems resulting from the use of non-Arrow tickets.

1. Adjust the dispensing column size, if necessary. Use the tabs located on the back of each column to make the adjustment.

- Pinch the upper right-hand tab of the column you wish to adjust.

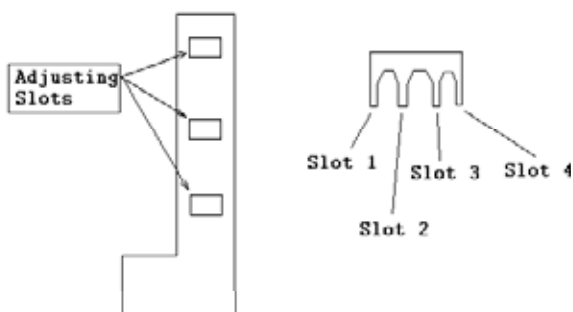

- Pinch the bottom left-hand tab of the same column.
- Lift the tabs to release from the positioning slots.
- The closest slot (slot #1) is used for 2 5/8" ticket lengths. Slot #2 is used for 3 1/4" ticket lengths. Slot #3 is used for 3 3/4" - 3 7/8" ticket lengths. Slot #4 is for 4 3/8" ticket lengths.

2. Load a single ticket. Make sure that both the upper and lower cabinet doors remain open.

Starting at the top of the column, slide a ticket down the chute until it reaches the lowest point. Rotate the large white gear at the bottom right of the column to advance the front edge of the ticket approximately one half to one inch into the feeder. No further adjustments for size are required. The front edge of the ticket remains lower than the back edge. **Note that the ticket is sitting in the column at an angle.**



3. Fill the column. First, check to see how the tickets bend. To prevent tickets from jamming and to ensure that tickets vend smoothly, make sure the tickets are loaded as illustrated. Reference label on inside of cabinet door for ticket loading.

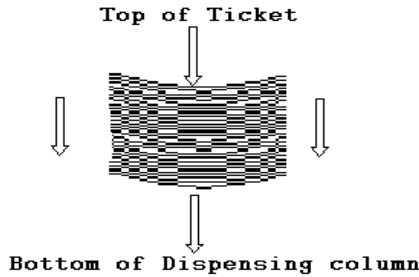

A wide opening at the top of each column allows you to enter stacks of tickets. Grasp a manageable stack of tickets. Slide the stack down the chute. Continue to load tickets until the column is full.

All tickets in one column must be of the same value.



4. Replace the retaining plate.

Once the column is filled, you must ensure that tickets placed in the wide entry slot do not fall out. Use the retaining plates (shaped like an H) to secure the tickets as follows:

- Place one hand in front of the tickets loaded in the top part of the column.
- Take the H-shaped retaining plate in the other hand.
- Insert the retaining plate in the slots at the top and behind the guide bar at the bottom.
- Lock the retaining plate into the slots at the top of the column.

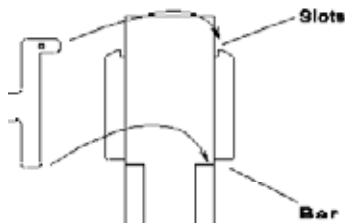

Removing Tickets

You can remove any tickets that do not load properly down the chute. Remove the H-shaped retaining plate. Slide the ticket or tickets back up to the top and out the wide entry opening. Reload the tickets. Replace the retaining plate.

Displaying Sample Tickets

A display rack contained in the upper cabinet door provides room and visibility to display sample tickets. Place a ticket in the rack so that when the door is closed the ticket type displays in front of the particular column from which the tickets will be dispensed.

BASIC OPERATION

Accessing Menus

The LCD (liquid crystal display) located on the outside of the upper right cabinet (as looking at the machine) provides the menu information for maintaining your Nevada Gold™ Pull Tab Dispenser.

When the doors are locked and the machine is ready to dispense tickets, the LCD appears as follows on models that accept only bills:

When the doors are locked and the machine is prepared to dispense tickets, the LCD appears as follows on models that accept both coins and bills:



INSERT MONEY
\$1.00 TO \$20.00

To set up or make changes, unlock the upper cabinet door and use the keypad located inside the door to program the changes. Once you open the door, the ENTER PIN NUMBER prompt displays.



INSERT MONEY
\$0.25 TO \$20.00

If you are using the dispenser for the first time, enter PIN number **1000** and then press #. Otherwise, enter your own PIN number and press #. The Main Menu will then appear:



PINS-1 TOTALS-2
PRICE-3 MORE-#

Pressing # will bring the following display:

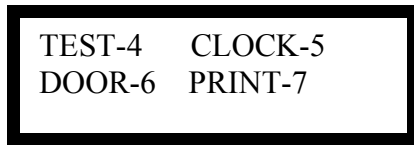

Pressing * will return you to the previous screen.

- Enter **0** to clear credits that have not been played
- Enter **1** to add, change or delete PIN numbers. See page 20.
- Enter **2** to view the total number of tickets dispensed for each column and an accumulated total, as well as the total currency collected. See page 20.
- Enter **3** to set ticket prices for each column. See page 22.
- Enter **4** to dispense tickets in a test mode. See page 23.
- Enter **5** to set the date and time. See page 24.
- Enter **6** to display the last 30 door openings in reverse chronological order. See page 26.
- Enter **7** to print out an accounting report. See page 40.
- Enter **8** for serial number entry (use if PRICING NOT SET, GO TO SERVICE to hold changes after resetting machine).

Managing PIN Numbers

You can add, change or delete up to five different PIN numbers.

You cannot access menu functions unless at least one PIN position contains a valid PIN number. 0000 is not a valid PIN number. Press **1** to select the PIN function. The PIN Menu displays.



To add or change a PIN number press *. NEW PIN displays. Enter the new PIN number or enter 0000 to delete a PIN number for that position. Press the # key to advance to the next position. After you modify the PIN number, press the # key. When you reach the last PIN position, the display returns to the Main Menu.

Tracking Sales

The Nevada Gold™ Pull Tab Dispenser records the total number of tickets dispensed from each column and provides a sum total of all tickets dispensed. In addition, the dispenser accumulates a total of all currency accepted. To review the Totals Menu, press 2 from the Main Menu.



TOTAL FOR COLS-1
TOTAL FOR CASH-2

To display the total ticket sales, press 1, TOTAL FOR COLS. The total for the first column displays, where **xx** is the column number and **0000000** displays the actual number of tickets dispensed from that column. **This amount is not erasable or resettable.**

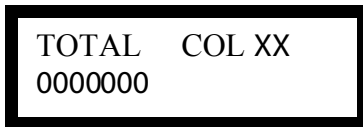

TOTAL COL XX
0000000

When you press # again, the resettable total appears. Pressing * will reset the total. Press # to advance to the next non-resettable column total. Pressing # again will advance you to the next resettable total. Once all columns are displayed, press # to display the non-resettable TOTAL ALL COLUMN amount. Press # again to display the resettable TOTAL ALL COLUMN amount.



TOTAL ALL COLUMN
0000000

Note that the Nevada Gold™ Pull Tab Dispenser is also equipped with two meters located inside the main cabinet door. The TOTAL ALL COLUMN amount equals the amount displayed on the bottom meter.



TOTAL CASH
\$0000000.00

To track the total value of currency accepted, press 2, TOT FOR CASH, from the Totals Menu. The following screen displays, where **\$0000000.00** is the actual currency total:

Press # to proceed to RESETTABLE TOTAL CASH. Pressing * resets the cash total to zero, while pressing # returns you to the main menu.

Note that the top meter located inside the main cabinet door matches the TOTAL CASH amount. If your machine accepts 25¢ coins, the top meter amount will be accurate within 75¢. For example, \$475.75 appears as \$475.00.

Establishing Column Ticket Pricing

The Nevada Gold™ Pull Tab Dispenser is shipped with six preset ticket values: ten cents, twenty-five cents, fifty cents, one dollar, two dollars or five dollars. Players select amounts to match the ticket value. **You must set the column amounts to equal the value of the tickets placed in the column.**

- Columns are numbered from left to right, beginning with column 1 on the far left.
- A column must display a value greater than \$0.00 to dispense tickets.
- A column must contain all tickets of the same value; for example, all tickets in column one must cost \$0.50.
- Set the price for the tickets one column at a time.
- **If the price set for the column does not match the price of the ticket, sales will not correctly represent the price of the ticket.**



From the Main Menu, Press **3**. The Pricing Menu appears:

Press the * key to select a preset value. When the proper amount displays, press the # key to advance to the next column. Repeat this step until all of the columns are priced. When you have finished entering the ticket prices, press the # key to return to the Main Menu. **All columns must have pricing set in order for the dispenser to enter vend mode.**



Note: On random select models, a minimum of two columns must be set to the same price before the unit can dispense tickets.



Testing the Dispensing Unit

The test feature allows you to ensure that tickets dispense accurately without affecting the actual total counters. Use the test mode to empty a column or columns prior to loading a different ticket type or prior to transporting the machine. Note the following:

- The total number of tickets dispensed displays while in this mode.
- You cannot test vend more than 100 tickets at a time.
- If you request more tickets than are available in the column, the column empties, the column dispensing mechanism shuts off and the total number of tickets dispensed displays.
- Totals do not accumulate in memory.
- Columns are numbered from left to right, beginning with column 1 on the far left.

From the Main Menu, press **4**. The Test Vend Menu appears.



SELECT COLUMN
000 PRESS #

Close the lower cabinet door.

1. Enter the test column number.
2. Enter the number of tickets you want to dispense.
3. Press # for tickets to dispense into the stacking compartments.

Setting the Date and Time (Random Column Select or Printer Upgrade Installed Only)

From the main menu, press **5**. If your dispenser is not a random column select or does not have the optional printer upgrade kit installed, the following will appear:



CLOCK OPTION
REQUIRED

After a short delay, the LCD will automatically return to the main menu. (Contact your local Arrow Distributor if you would like this option.)

Otherwise, the date and time currently in the unit will display:

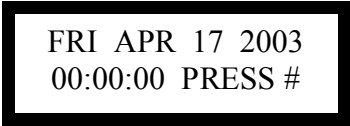

FRI APR 17 2003
00:00:00 PRESS #

Pressing **#** will return you to the main menu whereas pressing ***** will allow you to set a new date and time.

Press ***** and the following screen will appear:



MONTH:
PRESS #

Enter the applicable month in numerals (e.g.: Jan - 01, Feb - 02, etc.) and then press **#**, and the following screen appears:



DATE:
PRESS #

Enter the correct date (1-31) and press #. The following screen appears:

YEAR:
PRESS #

Enter the correct year (i.e.: **2003**) and press #. The following screen appears:

ENTER HOURS:
PRESS #

Enter the correct hour in 24-hour format (i.e.: 0-23) and press #. The following screen appears:

MINUTES:
PRESS #

Enter the correct minutes (0-59) and press #. The following screen will show the changes you have made:

FRI APR 17 2003
11:46:45 PRESS #

Press # to return to the main menu.

From the main menu press 5 to re-check the date and time settings.

The date and time will re-display. If they are correct, press # to return to the main menu, otherwise press * to enter the correct date and time.

Tracking Door Openings

On units that are either random column select or have the optional printer upgrade kit installed, the dispenser automatically tracks the date and time of the last 30 door openings in reverse chronological order.

From the main menu press **6**. If your dispenser is not a random column select unit or does not have the optional printer upgrade kit installed, the following will appear:



CLOCK OPTION
REQUIRED

After a short delay, the LCD will automatically return to the main menu. (Contact your local Arrow Distributor if you would like this option.)

Otherwise, the following screen will appear:

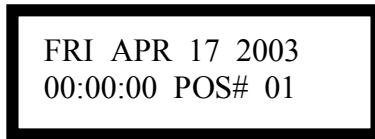

FRI APR 17 2003
00:00:00 POS# 01

This shows the date and time of the last door opening by the person with a valid PIN number in position # 1 (See page 20 for details on PIN numbers and positions).

Pressing # will show you the second last door opening. Pressing # again will show you the third last door opening, and so on.

At any time while viewing door openings, pressing * will return you to the main menu.

If an invalid PIN number was entered upon opening the door, the display will show:

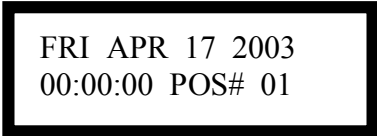

FRI APR 17 2003
00:00:00 POS# 01

The date and time when the invalid PIN number was entered. Note that a valid POS # was not entered.

Reading The Dispenser's Serial Number

From the main menu, press 8. The machines serial number will appear on the LCD which will match the serial number on the identification tag on the lower left hand side of your unit. Pressing # will take you back to the main menu.

Clearing Established Credits

If you wish to clear any credits established in the dispenser without dispensing tickets, from the main menu press 0, and the following will appear on the LCD:



CLEAR CREDITS
1 – YES 2 – NO

Press **1** if you want to clear the established credits or **2** if you do not.

Resetting Error Messages

Error messages appear for two reasons: a ticket column is empty or a malfunction in a column has occurred. This section describes how to correct the problem in each of these situations. The first time the problem is detected, the LCD displays the total number of credits remaining:



\$0.00 CREDIT

If the player selects again from the same column, the LCD displays the following prompt:



COLUMN EMPTY
OR MALFUNCTION

When the message appears because an empty column has been selected, another column must be chosen if the player wishes to continue.

To reset the message before resuming play:

1. Unlock and open the upper cabinet door.
2. Enter your PIN number.
3. Load tickets. (See page 14 for details.)
4. Close and lock cabinet door.
5. Resume play.

Note that when you reload the column with tickets, the player does not lose any credits.

If the message appears for a reason other than an empty ticket column, you must first determine the reason for the malfunction. Tickets will not dispense for one of three reasons: **a ticket jam, a misaligned sensor, or a dirty sensor.**

To reset an error message resulting from a ticket jam:

1. Unlock and open the upper cabinet door.
2. Enter your PIN number.
3. Locate the column with lodged ticket.
4. Turn the large white gear to the right of the column with the jam until the ticket can be removed.



5. Remove the ticket.
6. Close and lock cabinet door.
7. Resume play.

To reset an error message caused by misalignment of a sensor:

1. Unlock and open the upper cabinet door.
2. Enter your PIN number.
3. Determine which sensor is out of alignment. Note that the sensor must face down towards the ticket.
4. Remove the guard above the sensor by removing the nut attaching the guard with a 5/16" open end wrench.
5. Align the sensor above but not touching the ticket. The bottom of the sensor is 1/8 inch to 1/4 inch above the ticket. Use a 1/4 inch wrench and a Phillips screwdriver to tighten. The sensor's location is as follows:
6. Reinstall the sensor guard.
7. Test the column (see page 23).
8. Close and lock cabinet door.
9. Resume play.

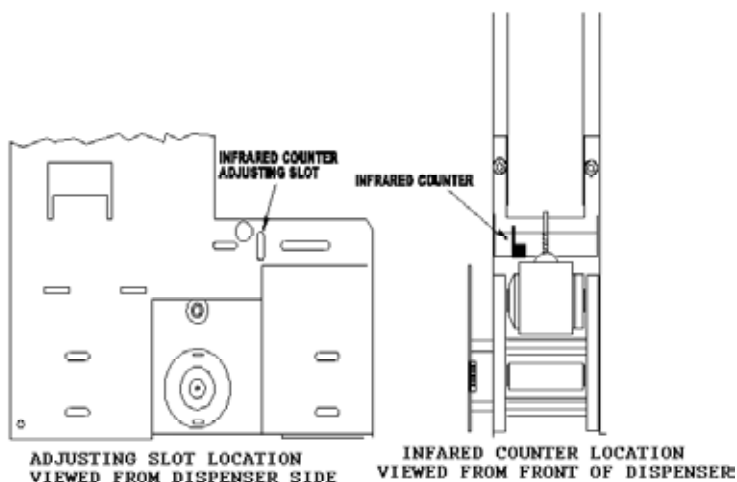

Emptying the Cash

In order to empty the cash from the bill acceptor, follow these steps:

1. Unlock main cabinet door and swing out of the way.
2. Unlock and open the bill acceptor door.
3. Remove the cassette from the bill acceptor by pressing your fingers against both cassette latches. At the same time, rotate the cassette at an angle of about 15-20 degrees.
4. Pull the cassette off of the bill acceptor.
5. Open the cassette by rotating the lever at the back of the cassette, and remove the bills.
6. Reinstall the cassette.
7. Close and lock door.

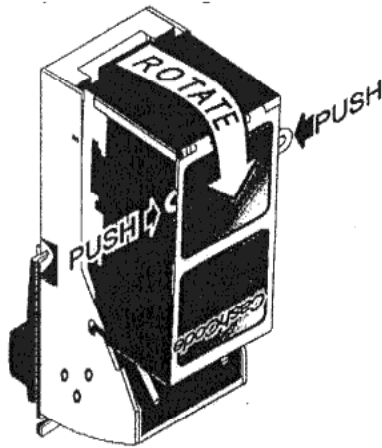

If your dispenser is equipped with a coin acceptor (selected models only), complete the following steps to empty the coins:

1. Unlock and open the coin acceptor door.
2. Remove and empty the coin box.
3. Reinstall the empty coin box.
4. Close and lock the coin acceptor door.

OPTIONAL VIDEO DISPLAY





If your dispenser has the optional video display installed, the unit is capable of presenting fixed images in **JPG** format and video with sound in **DIVX AVI** format.

Specifications:

- LCD resolution: 480X234, contrast and brightness adjustable;
- Working temperature: -10 OC – +40OC;
- Humidity: 10% – 80%;
- Storage temperature: -20OC – 70OC;
- Voltage: Adapter: AC 90V-240V~50/60HZ; Player: DC12V;
- Current: 360mA-600mA; Sleep: 200mA; Standby 4.8mA

BUTTON DEFINITION

Button definition as follows (from left to right):

- UP 
- DOWN 
- LEFT 
- RIGHT 
- ENTER/PLAY/PAUSE
- MENU
- SETUP



Video Display Settings

TIME SETTING

In the main menu, press or , move the cursor to the icon **[Clock]**
Press to select **[Clock]** function.



Press or , move the cursor to **[SET TIME]**, then press and select the function to set time.

Press or to select HH/MM/SS then press or to adjust the selected item. If it is ok, press , then press to save the setting.

DATE SETTING

Select the item **[SET DATE]** then use the same step as time setting. After the setting, press to save it.



AUTO POWER

Power On Enable and Power Off Enable will turn the display on or off at a predetermined time.

Leave them both OFF to allow the display to run continuously.

Press or to select **[Auto Power On/Off]**, to set the function of power on/off.

TO SET POWER ON ENABLE (if desired)

Press the arrow buttons to move the cursor to **[ON]**, press to save it.

Or

Press the arrow buttons to move the cursor to **[OFF]**, press to save it.

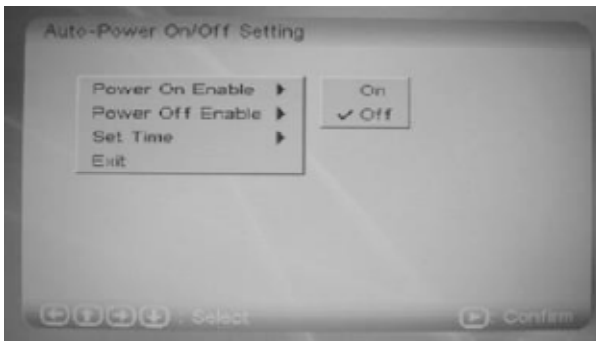

TO SET POWER OFF ENABLE (If desired)

If the Power Off Enable is OFF then the display will function as long as power is applied.

Press the arrow buttons to move the cursor to **[ON]**, press to save.

Or

Press the arrow buttons to move the cursor to **[OFF]**, press to save.

If the Power On Enable and/or Power Off Enable are used, the Power On and Power Off times must be set. To set the time of Power on/off: Move the cursor to **[SET TIME]**, the power on time and power off time can be set separately. It is similar to setting the clock. Note: The clock must be set for this to function properly.

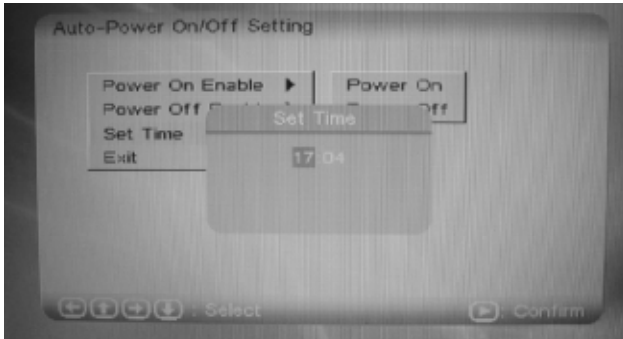

After finishing above setting, move the cursor to **[OFF]**, press **ENTER** to exit the setting, thus end the setting of the power on/off.

System Settings

MEDIA FORMAT SELECTION

Movie is the default format when power on, diagram as follows.





Images

Images and videos must be stored on a Secure Digital (SD) memory card. A 1G card is recommended. Place the image (JPG) and the video (AVI) files directly onto the SD card. Do not use folders. The display will automatically play the images and videos on the card.

The images (JPG) can be rotated by pressing the buttons as follows while it is playing. Each image must be set individually.

 Mirrors image from left to right

 Mirrors image from top to bottom



 Rotates image clockwise

 Rotates image counter clockwise

NOTE: The orientation will return to the original position when power is removed. It is recommended that the actual JPG or AVI image be rotated to the desired orientation prior to placing the file on the SD card. This can be done in any of the readily available graphics programs.

The videos (AVI) can not be rotated or mirrored.

The volume can be changed as follows only while the video is playing:

Press the  or  to change the volume

Display Configuration

Press or to select **[TFT Brightness]**

Press or 0,+1,+2,+3,+4,+5,+6,+7;-1,-2,-3,-4,-5,-6,-7, to adjust the brightness then press to save.

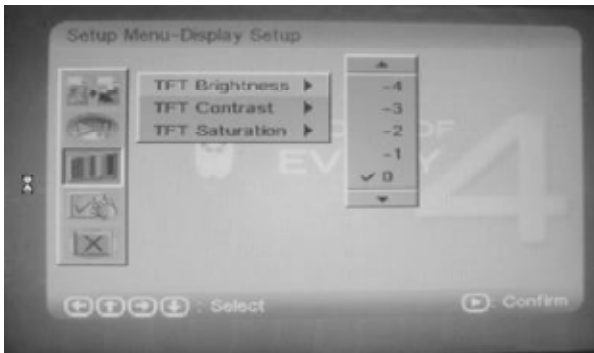

Press or to select and set **[TFT Contrast]**, the same method as brightness.

Press or to select and set **[TFT Saturation]**, the same method as brightness.

ON SCREEN DISPLAY LANGUAGE

Press the arrow buttons to select **[OSD Language]**. There are English/French/German/Italian/Spanish/etc for selection. Press **ENTER** to save after certain language is selected.

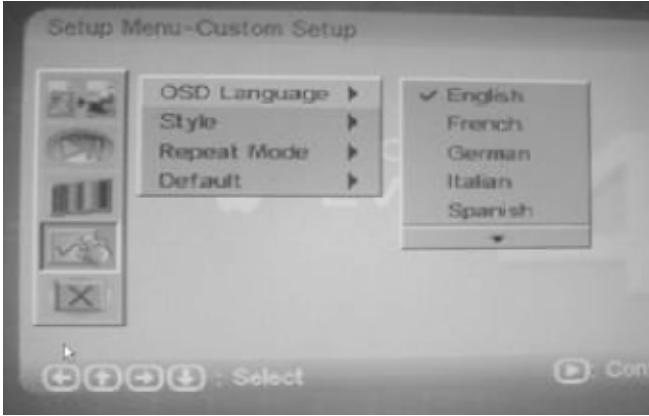

Press **↓** or **↑** to select **[Style]**. There are 4 background styles: Style1, Style2, Style3, Style4, press **ENTER** to save the configuration.



Press or to select **[Default]**. This will restore the configuration to the default.

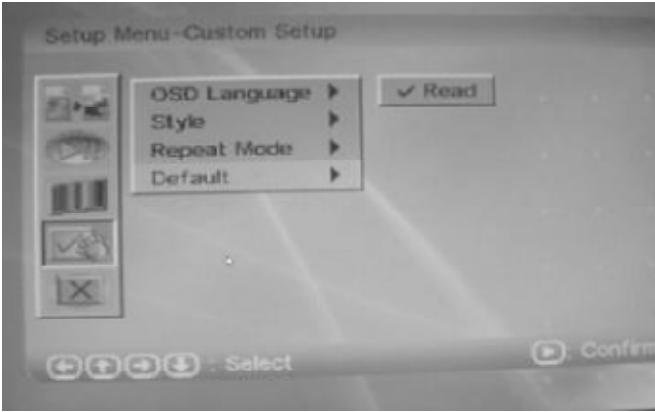

OPTIONAL REPORT PRINTER

If your dispenser has the optional printer upgrade kit installed, the unit is capable of generating a hard copy report of all the accounting information in the unit. The unique design of the printer upgrade kit allows one printer to generate a report for any number of dispensers.

Generating the Report

To print out the hard copy report, complete the following steps:

1. Unlock and open the main cabinet door and enter your four digit PIN #.
2. Plug the portable report printer into the telephone jack which is below the keypad inside the cabinet.
3. From the main menu press **7**.

The printer will then begin printing a report similar to this:



NEVADA GOLD REPORT

MON OCT 19 1998

10:52:56

SERIAL NUMBER:

0000000

PIN POSITION #5

COLUMN #1

PRICE: \$0.00

TOTAL TICKETS DISPENSED: 0

RESETTABLE TOTAL: 0

COLUMN #2

PRICE: \$0.00

TOTAL TICKETS DISPENSED: 0

RESETTABLE TOTAL: 0

COLUMN #3
PRICE: \$0.00
TOTAL TICKETS DISPENSED: 0
RESETTABLE TOTAL: 0

COLUMN #4
PRICE: \$0.00
TOTAL TICKETS DISPENSED: 0
RESETTABLE TOTAL: 0

TOTAL OF ALL COLUMNS: 0
RESETTABLE TOTAL: 0

TOTAL CASH ACCEPTED: \$0.00

RESETTABLE CASH TOTAL: \$0.00

-- END OF REPORT --

This report details all the accounting information present in the dispenser, including:

- The date and time the report was generated,
- The serial number of the dispenser,
- The PIN position # of the person generating the report,
- The price, total tickets dispensed and resettable total tickets dispensed by column,
- The total number of tickets dispensed in all columns,
- The resettable total number of tickets dispensed in all columns,
- The total amount of cash accepted and,
- The resettable total amount of cash accepted.

NOTE: If your dispenser does not have the optional printer upgrade kit installed, when you press **7** from the main menu, the display will read as follows:



After a short delay, the LCD will automatically return to the main menu. (Contact your Arrow Distributor if you would like this option.)

If you do not plug in the printer when you select **7** from the main menu, the display will read as follows:



After a short delay, the LCD will automatically return to the main menu. Plug in the printer, or turn the printer on and press **7** again.

PLAYER INFORMATION

Player instructions are located on the front of the dispenser underneath the bill acceptor.

Dispensing Tickets

Players must check the LCD display for ticket dispensing instructions. The unit only accepts currency when the doors are locked and the bill validator light appears green. When the doors are locked and no credits appear, the LCD display appears as follows on models that accept **only bills**:



INSERT MONEY
\$1.00 TO \$20.00

If your model accepts both coins and bills, the following display appears:



INSERT MONEY
\$0.25 TO \$20.00

Once you insert money into the machine, you see:

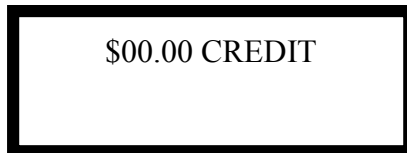

\$00.00 CREDIT

Note that \$00.00 represents the amount of the credit available.

SELECTING THE PLAYALL BUTTON

Use the PLAYALL feature to dispense 100 tickets maximum from a single column (or 100 tickets randomly from all columns set at the same price on random models). If all credits are not used up, the remaining credits will be displayed when vending is completed. When you select the PLAY ALL button, the following screen appears:

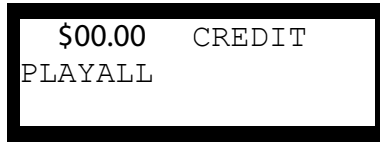

SELECTING A COLUMN BUTTON

You can dispense tickets one at a time by selecting a particular column. When you select a column, the following display appears on the LCD:

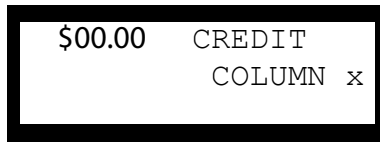

Note that the column number selected appears, not x.

On random models, a single ticket will be dispensed randomly from any column set at the chosen price.

CARE AND MAINTENANCE



Your model of the Nevada Gold™ Pull Tab Dispenser has been manufactured to exceed mechanical and electronic standards. The following information will assist you in the care and maintenance of your unit.

- Keep the unit dry. If it gets wet, wipe it dry immediately. Liquids can damage the electronic circuits.
- Wipe the unit with a damp cloth and a drop of liquid fabric softener to keep it looking new. Do not use any abrasive cleaning materials or solvents to clean your model.
- Handle any removed parts gently and carefully. Dropping or mishandling parts can damage electronic components.
- Use plastic cleaning implements or a soft cloth to remove dust from inside the unit. Metal tools can damage the electronic components.
- Use light lubricants and precision oiling implements to lubricate the rollers, shafts and the chute door.

Lubricating the Chute Door

When dust from the tickets accumulates, the chute door can stick or become difficult to open or close. To prevent this from happening, lubricate the four pins on the chute door every three to six months. Using an aerosol lubricant with a straw attachment, spray each of the four pins carefully.

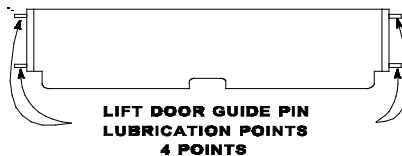

Lubricating the Accelerator Roller Shafts

Occasionally, the accelerator rollers can grind or squeal. To prevent this from happening, you should lubricate the rollers and the transfer shaft every three to six months. Using any light lubricant and a precision oiler, put a drop of oil on each side of the accelerator roller and the transfer bottom shaft. **Do not get any oil on the rubber surface.**

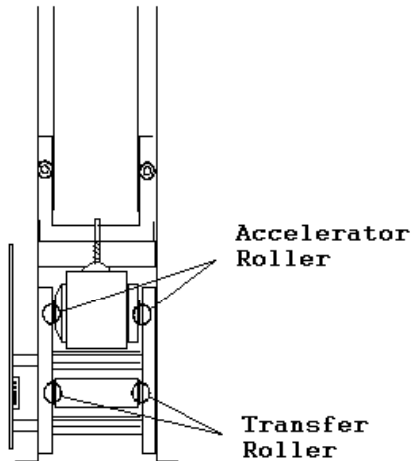

Cleaning the Infrared Sensor

About every 100,000 tickets or three months, you should remove any dust build-up from the ticket counter infrared sensor. Failure to do this could result in miscounting of tickets. To clean the sensor:

1. Looking from the front of the dispenser, insert a Q-Tip, underneath the sensor.
2. Gently rub the bottom of the sensor to remove the paper dust, or
3. Use a can of compressed air to blow out the dust.

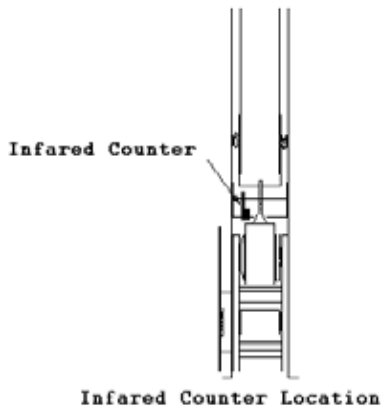

Cleaning the Bill Validator

A build up of dust and dirt in the bill validator may affect the acceptance rate of genuine bills. To prevent this, you should clean the bill validator every 3 months. To clean the validator, complete the following steps:

1. Remove the cassette from the bill validator. (See page 30)
2. Open the two covers of the banknote pathway by pressing the button labeled "PUSH".
3. Use a soft cloth or brush to gently clean the optical sensors and bill pathway. Do not get fingerprints on the optical sensors.
4. To clean the magnetic heads, moisten a cloth with soap and water and gently rub the heads.
5. **DO NOT OIL THE BILL VALIDATOR** – Oiling of validator will void the warranty.



Cleaning the Coin Acceptor

A build-up of dust and dirt in the coin acceptor may affect the acceptance of genuine coins. To prevent this, the coin acceptor should be cleaned every 3 months. To clean the acceptor, complete the following steps:

1. Open the spring-loaded hinged cover on the left side of the acceptor.
2. Using a damp cloth, wipe clean.
3. Let acceptor dry thoroughly before reinstallation.

Clearing Jammed Bills

If a severely damaged bill is inserted into the bill acceptor, there is a possibility that the bill may jam when it goes into the stacking cassette. To remove a jammed bill:

1. Remove the cassette carefully, trying not to damage the jammed bill (See page 30.)
2. Open the two covers of the banknote pathway by pressing the button labeled "PUSH".
3. Remove the jammed bill.

Replacing a Ticket Column

If a ticket column requires replacement, complete the following steps:

1. **Unplug the dispenser.**
2. **Disconnect the battery wire.** (See page 11)
3. Loosen the column retaining plate that is located beside the wide opening between every second column. Use a 3/8 inch socket wrench to loosen the nut and rotate the plate from its horizontal to a vertical position.

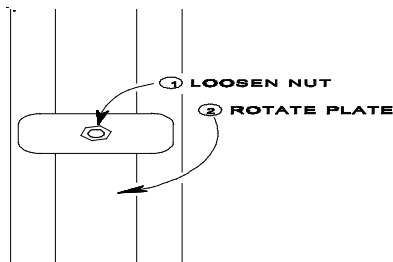

4. Disconnect the 14 Conductor Ribbon Cable located on the back plane and remove the five Philips screws from the back plane.
5. Pull the backplane circuit board straight out to disconnect the pins from the columns.
6. Place the circuit board, with the pin connectors facing up, on a level surface to avoid damaging the pins.

5 PIN CONNECTORS ON BACKPLANE **MUST** LINE UP WITH THESE CONNECTORS

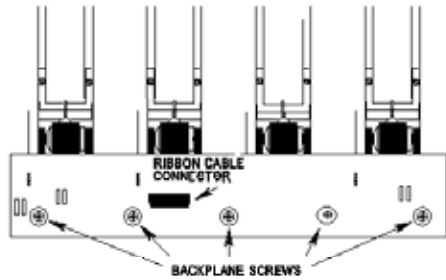
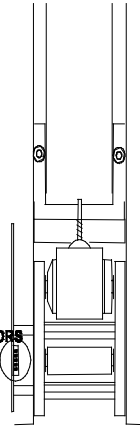

7. Place one hand on the top of the column, one hand on the bottom of the column and slide the column out of the unit.
8. Slide the new column in, making sure that the column fits in properly.
9. Align the pins on the backplane circuit board with the plugs on the column circuit boards. (You may have to adjust the position of the columns slightly to ensure this.) **NOTE: You must ensure that the pins are aligned correctly.** Push the pins gently in place. 
10. Put the circuit board in place and screw in the five screws. Replace the 14 Conductor Ribbon Cable.
11. Return the retaining plate to the horizontal position and tighten the retaining plate.
12. Connect the battery. (See page 11 for details.)
13. Plug in the unit.
14. Test vend tickets from each column to ensure that the circuits are connected. (See page 23 for testing instructions.)

Adjusting For Different Ticket Thickness

The Nevada Gold™ Pull Tab Dispenser adjusts to accommodate tickets that vary in thickness. To make the adjustment, you require one 11/32 inch socket.

1. Loosen the gate height adjustment nuts on either side of the ticket feeder.

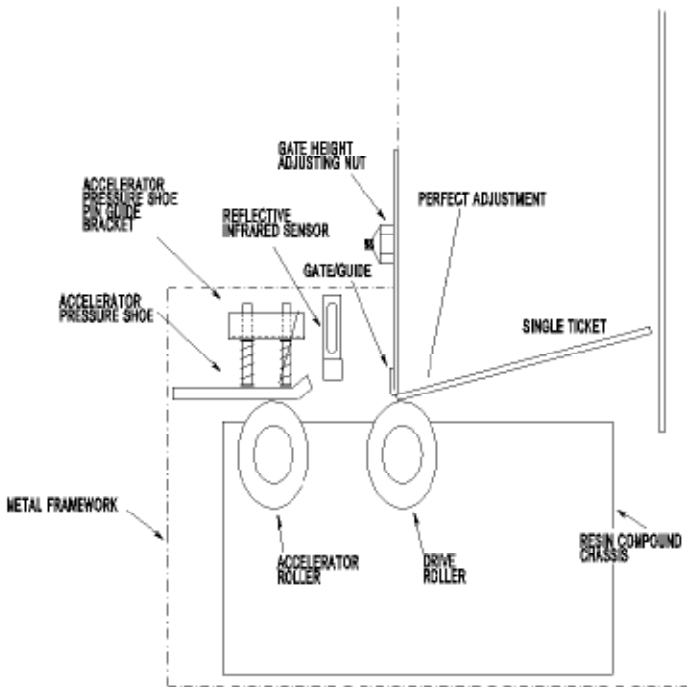

2. Adjust upwards for thicker tickets. Adjust downwards for thinner tickets.
3. Test adjustment.
 - Slide a single ticket down the ticket chute.
 - If the ticket slides through the feeder, the gap is too wide for the ticket. Adjust downwards.
 - If the ticket does not feed through the feeder when the large white gear is turned, the gap is too narrow for the ticket. Adjust upwards.
 - If the ticket stops at the front edge of the stainless steel gate and moves forward when the large white gear is turned, the adjustment is complete. (See diagram, page 49)

Notice that the ticket is sitting in the column at an angle.
4. Tighten the nuts gradually, alternating from side to side to ensure that the tooth of the gate stays parallel with the ticket. **Do not over tighten.**



5. Test vend tickets from each column to ensure that the correct number of tickets dispense. (See page 23 for testing instructions)

Note: The dispensing columns are factory preset to accept tickets .024 inches thick. You do not have to adjust the columns unless you are using a ticket which is a different thickness.



Ticket thicknesses can vary due to storage conditions. Humidity, heat, or cold can sometimes vary the ticket thickness or severely warp the ticket. To insure proper operation, store your tickets in a cool dry place away from direct sunlight.

RANDOM NUMBER GENERATOR FEATURES

Optional Random Ticket Dispense

When in random dispense mode, 'Play All' switch will randomly select up to 100 tickets from columns until credits are depleted. Only columns that are of the same price will dispense tickets.

If you would like this function installed, contact your local Arrow distributor for more information.

You will need to set pricing on at least 2 columns to be able to use the 'Play All' function when in random dispense.

TROUBLESHOOTING

Problem	Explanation
<p>An incorrect number of tickets continue to dispense from a column.</p>	<ol style="list-style-type: none"> 1. Check ticket pricing for the column. Make sure that the price of the ticket matches the price set for the column; or 2. Clean the infrared sensor, see page 46. 3. Check the infrared sensor. Make sure the sensor is aligned. If the sensor is out of place, see page 46 for details on aligning the sensor.
<p>Remaining credits do not dispense after the AC power is disconnected.</p>	<p>Connect the back-up battery. See page 11 for details.</p>
<p>Credits display but no tickets dispense.</p>	<p>Check the value of the tickets in the dispenser. If the remaining tickets in the dispenser are not divisible by the credit amount; for example, a \$1.00 credit displays, but the machine has only \$2.00 tickets.</p> <ol style="list-style-type: none"> 1. Enter more money. 2. Fill an empty column with a ticket of a different value. See page 16 for details.
<p>LCD displays text but the back lighting is not on and the bill acceptor light is red.</p>	<p>No AC power to unit. Make sure AC power supply is plugged in and the ON/OFF switch is ON.</p>

TROUBLESHOOTING (cont'd)

Problem	Explanation
<p>Bill acceptor does not accept currency and the indicator light remains red.</p>	<ol style="list-style-type: none"> 1. Check the amount of credit already established. If more than \$80.00 worth of credit appears, tickets must be dispensed until a credit value of \$80.00 or less appears; or 2. Check to ensure that the cabinet door is locked. No cash is accepted when the cabinet door is open; or 3. Check to see if the bill acceptor is full. No cash is accepted when the bill acceptor is full. See page 30 for instructions on emptying the bill acceptor. 4. Check bill validator diagnostics, page 56.
<p>Tickets do not dispense.</p>	<p>Check the chute door. Tickets do not dispense when the chute door is not completely closed. Lubricate the chute door if necessary, see page 45.</p>
<p>Column makes grinding or squealing noise when tickets are dispensing.</p>	<p>Make sure that the unit has been properly maintained. Refer to page 46 on how to lubricate the roller shafts.</p>
<p>Tickets do not dispense from column selected.</p>	<p>Is your dispenser a random select model? Tickets will randomly dispense from all columns set to the same price as the column selected.</p>

TROUBLESHOOTING (cont'd)

Problem	Explanation
<p>"COLUMN EMPTY OR MALFUNCTION" appears on the LCD.</p>	<ol style="list-style-type: none"> 1. The column selected does not have any tickets loaded. Load more tickets into the column. See page 16. 2. On random select models, at least two columns must be set to the same price AND have tickets loaded. See page 16 for loading tickets and page 22 for setting ticket pricing. 3. A ticket could be jammed in the column. See page 28 to clear the jam.
<p>Alarm activated.</p>	<ol style="list-style-type: none"> 1. Make sure that the cabinet doors are closed and locked. The alarm will sound if any one of the cabinet doors is open and the ticket pricing has already been set; or 2. Make sure that the unit is plugged in. The alarm sounds if the unit is unplugged for more than seven seconds; or 3. A power failure lasting more than seven seconds causes the alarm to sound. <p>To reset the alarm:</p> <ul style="list-style-type: none"> • Open door. • Enter PIN number. • Close and lock door. • Plug in, if unplugged, or wait for power to be restored.

TROUBLESHOOTING (cont'd)

Problem	Explanation
CLOCK OPTION REQUIRED or PRINTER OPTION REQUIRED appears on the LCD	Your dispenser is not equipped with the optional printer upgrade kit. The option on the main menu which was selected is not available until the printer upgrade kit is installed. Contact your Arrow distributor for information on obtaining this kit.

Bill Validator Diagnostics

If the red light on the front of the bill validator is ON when the doors are locked and no credit appears, insert a bill and remove it. After the red light goes OFF, count the number of times the light flashes, and compare it with the chart below:

Number of flashes	Explanation
0	No faults - Validator is working properly
1	The cassette is removed from the bill validator. Install the cassette. See page 30 for information on the cassette.
2	The stacking motor does not rotate. Possible jammed bill. See page 48 to clear the jam.
3	The cassette is full. Empty the cassette (see page 30 for information on emptying the cassette).
4	A mechanical jam in the cassette. See page 48 to clear the jam.
5	There is a stacking motor electrical overload. Contact your Arrow distributor.
6	Failure of optical sensors occurred. Clean the sensors (see page 46).
7	Failure of magnetic sensors occurred. Clean the sensors (see page 46).
8	The transporting motor does not rotate. Clean the bill pathway (see page 48) or clear a jammed bill (page 48).
9	The speed of the transporting motor is too fast. Contact your Arrow distributor.
10	There is a transporting motor electrical overload. Contact your Arrow distributor.
11	The bill pathway security latch is open. Close the latch.
12	The banknote is in the entry slot of the cassette and credits were not issued. Contact your Arrow distributor.

Note that if the red light on the front of the bill acceptor did not go OFF when a bill was inserted, a failure in communication between the bill acceptor and the CPU of the dispenser has occurred. Contact your Arrow distributor.

When the diagnostics are complete, the red light stops flashing.

SPECIFICATIONS

Physical Characteristics

Power Supply Input:	110/120V AC
Power Supply Output:	16V AC
Operating Temperature:	40 to 95 °F (5 to 35°C)
Power Consumption:	40VA Max.

Dimensions:	4-Column	8-Column
Width:	24 ½ inches	42 5/8 inches
Depth:	15 ¼ inches	15 ¼ inches
Height:	36 5/8 inches	36 5/8 inches
Weight (empty):	145 lbs.	225 lbs.

CAPITOL BINGO EQUIPMENT LIMITED WARRANTY

Set out below are the terms of the Limited Warranty made by Arrow International, Inc. ("Arrow") in connection with the sale of the Capitol Bingo Equipment (the "Equipment").

1. Limited Warranty

Arrow warrants to the original purchaser ("Purchaser") that the Equipment will, for a period of ONE (1) YEAR from the date of original purchase of any equipment in the product line from an authorized Arrow dealer, be free from manufacturing defects in material and workmanship. Purchaser represents to Arrow that no employee, agent, or representative of Arrow (or of an Arrow dealer) has made any representation or warranty regarding the Equipment except as set out herein.

This Limited Warranty applies to normal commercial use and does not cover failures or damage which (a) occur in shipment; (b) is caused by products not supplied by Arrow; or (c) result from accident, misuse, abuse, neglect, mishandling, misapplication, alteration, set-up adjustments or modifications. This Limited Warranty also does not cover (i) any damage to the Equipment resulting from failure to install in strict conformity with both local fire and building codes and regulations, (ii) if installation does not comply with the installation instructions provided by Arrow, or (iii) consumable items such as filters or bulbs.

2. Disclaimer of Warranties

ARROW MAKES NO WARRANTIES, EXPRESS OR IMPLIED (INCLUDING, WITHOUT LIMITATION, MERCHANTABILITY, FITNESS FOR A PARTICULAR PURPOSE, OR AGAINST INFRINGEMENT OF ANY PATENT), EXCEPT AS EXPRESSLY PROVIDED HEREIN. THE EXPRESS WARRANTIES PROVIDED HEREIN ARE IN LIEU OF AND EXCLUDE ALL OTHER WARRANTIES, GUARANTEES OR REPRESENTATIONS, EXPRESS OR IMPLIED, WHETHER ARISING BY OPERATION OF LAW OR OTHERWISE.

3. Limitation of Remedies

If the Equipment supplied does not conform to the Limited Warranty set out above, Arrow will, at its option, (a) repair or replace the Equipment, or part thereof, which is defective or (b) refund so much of the purchase price as Purchaser has paid for the defective Equipment, less 1/3rd of the purchase price for each month between the date of the purchase from an authorized Arrow dealer and the date of the discovery of the defect, provided that written notice of the defect and its nature is given to Arrow as soon as practical after discovery of the defect, but in no event later than 15 days from the date of the discovery of the defect.

4. Limitation of Liability

The remedy of repair, replacement, or refund of the purchase price is Purchaser's sole and exclusive remedy and will satisfy all of Arrow's liabilities, whether based on contract, negligence, tort, product liability, strict liability, or otherwise. IN NO EVENT WILL ARROW BE LIABLE FOR INCIDENTAL OR CONSEQUENTIAL DAMAGES, NOR WILL ITS INABILITY IN CONNECTION WITH ANY EQUIPMENT OR SERVICE SOLD (INCLUDING NONDELIVERY OR LATE DELIVERY THEREOF) EXCEED THE SALES PRICE OF SUCH EQUIPMENT OR SERVICE.

5. Warranty Voided

Any obligations of Arrow under this Limited Warranty will be deemed to have been satisfied if anyone other than an authorized Capitol Bingo Equipment Dealer services the Equipment.

6. Transfer Of Limited Warranty

Purchaser may transfer its rights under this Limited Warranty subject to the terms and conditions hereof, to a buyer ("Buyer") from Purchaser of the Equipment. Thereafter, the rights under this Limited Warranty are not transferable. For the transfer by Purchaser of the Limited Warranty to be effective, the following conditions must have occurred no later than the 30th day following the date of resale to Buyer:

A. Purchaser must have complied with all requirements to make the Limited Warranty effective as to Purchaser; and

B. The Equipment (as an entire unit and as purchased by Purchaser) must be transferred to Buyer. Upon an effective transfer of this Limited Warranty, Buyer will be considered to be "Purchaser" for paragraphs 1, 4 and 8 hereof.

7. Inspection

With respect to any claim that the Equipment is defective, Arrow will be allowed a reasonable time to inspect the Equipment, in place. If the Equipment is altered or removed before Arrow has made such inspection or waived its right to do so, the obligations of Arrow under this Limited Warranty will be deemed to have been satisfied.

8. Proof of Purchase

Notwithstanding anything to the contrary in this Limited Warranty, Purchaser must, upon Arrow's request, submit proof of original purchase (satisfactory to Arrow) of the Equipment. The Limited Warranty set out above shall not apply to, nor cover, any Equipment for which Purchaser is unable, upon Arrow's request, to supply such proof of purchase.

9. Limitation of Actions

Any legal action against Arrow for a default of its obligations under this Limited Warranty must be commenced within two years from the date the Equipment was sold by an authorized dealer of the Equipment.

10. How to Obtain Service

If a Problem with this Equipment develops during or after the warranty period, proceed as follows:

A. Refer to your Operator's Manual and follow the Troubleshooting Table within the "Care and Maintenance" section.

B. Contact the authorized Capitol Bingo Equipment Distributor from whom you purchased the Equipment.

C. Contact the Capitol Bingo Equipment Service Manager at the most convenient phone number listed below:

(800) 321-0757 outside Ohio, but within the U.S.A.

(800) 537-3479 within the state of Ohio

(216) 961-3500 within the 216 area code or outside the continental U.S.A.

(216) 961-3641 fax number in Cleveland, Ohio

(800) 387-7621 within Ontario

(519) 770-4621 outside Ontario, but within Canada

(905) 670-0324 fax number in Canada

SERVICE CALLS WHICH DO NOT INVOLVE DEFECTIVE MATERIALS OR WORKMANSHIP AS DETERMINED BY ARROW IN ITS SOLE DISCRETION, ARE NOT COVERED. COST OF SUCH SERVICE CALLS ARE THE RESPONSIBILITY OF THE PURCHASER.

Arrow wants you to remain a satisfied customer. If a problem occurs that cannot be resolved to your satisfaction, please contact us immediately, Phone one of the numbers listed above or write to:

Capitol Bingo Equipment Division	Arrow Games (Canada) Inc.
c/o National Service Manager	1245 Lorimar Drive
9900 Clinton Road	Mississauga, Ontario
Cleveland, Ohio 44144	L5S 1R2

Please be sure to include the name, model number, serial number, date of original purchase, and the distributor from whom you purchased the Equipment, as well as any actions taken to correct the problem.

Capitol® Bingo Equipment
from Arrow International, Inc.



**HIGH QUALITY EQUIPMENT MANUFACTURED TO BE YOUR
FOUNDATION FOR SAFETY, RELIABILITY AND SERVICE**

PROTECT YOUR INVESTMENT



Arrow Technical Assistance Center

*Protecting Your Investment Through
Innovative Solutions and Support*

Phone Support Hours: 8:00 AM to 12:00 AM

800-277-6214

www.arrowinternational.com

WARNING:

You must keep your receipt or invoice for proof of purchase in order to insure proper warranty coverage.

**ARROW INTERNATIONAL, INC.
ARROW GAMES (CANADA) INC.**

9900 Clinton Road, Cleveland, Ohio 44144

(800) 321-0757 outside Ohio, but within the U.S.A.

(800) 537-3479 within the state of Ohio

(216) 961-3500 within the 216 area code or outside the continental U.S.A.

(216) 961-3641 U.S. FAX

(800) 387-7621 within Ontario

(519) 770-4621 outside Ontario, but within Canada

(519) 770-4872 Canada FAX

www.arrowinternational.com

Nevada Gold



68300