

# COLOR STATESMAN™ BINGO SYSTEM OPERATOR'S MANUAL

ARROW INTERNATIONAL  
CAPITOL BINGO  
EQUIPMENT DIVISION



Thank you for choosing to purchase Arrow International's Capitol Bingo Equipment. We are confident that you will be completely satisfied with our high quality, durable bingo equipment. Our Capitol Bingo Equipment has the most technologically advanced electronics and is designed for easy and reliable operations and trouble-free maintenance by the operator.

Arrow manufactures the highest furniture quality, hand crafted equipment consoles in the industry. Our metal fabricated steel masterboards are constructed of the finest, heavy duty materials available and guaranteed to withstand many years of use.

This revised bingo equipment manual introduces you to the many new features of the Color Statesman™ system. It will take you step by step through unpacking and installing the system. It will show you how to program and run games easily, and how to operate your new bingo system. Easy to follow instructions and illustrations also guide you through routine service and maintenance.

Arrow's hard work and dedication enable us to offer you a breadth of product line that continues to grow. We are proud to offer you the most extensive charitable fundraising product line consisting of high-quality, easy to open Popp-Opens® pull tabs; "top shelf" banded jar tickets; the largest series of bingo paper available in the largest variety of colors, patterns and cuts to meet your game's needs; Tear Opens™; and our popular Bingo Brite® and Dabbin' Fever® bingo markers. This dedication to providing an extensive line of high quality products is accompanied by our commitment to satisfying your product needs with fast and trouble-free service. Please visit us online at [www.arrowinternational.com](http://www.arrowinternational.com) for the latest in all of our product lines.

We value you as a customer and always welcome and appreciate your comments and suggestions to help improve our products. Our best suggestions always come from our game operators and distributors. We want you to always be a satisfied customer and we will continue to design and improve our products through the valuable feedback received from you and our outstanding network of Arrow distributors.

Once again, thank you for choosing Arrow International/Capitol for your charitable fundraising needs.

Arrow International



# Introduction

---

Your new CAPITOL STATESMAN COLOR Bingo System console was designed using state-of-the-art technology. Its modern design, woodgrain console and exceptional user convenience have set it apart from the competition.

The Color Statesman features flashing B-I-N-G-O letters corresponding with the last number called on the flashboard; one-hundred pre-programmed game patterns; up to 140 user-programmable game patterns; up to 20 bingo sessions—each consisting of up to 50 games with up to five progressive game patterns, dollar value and ball timer; verifier with Arrow/Capitol 54,000 Series and Dab-All™ 36,000 Series; UniMax, Mini Dab-All-75® 24,000 Series, Dual Dab 3,000 Series automatic video control; tear open capability; wild-number entry; real-time clock; random-number generator (optional); ball tray memory; system test; color composite video output, VCR compatibility and much more.

Digital communication from the console to the flashboard eliminates bulky, complicated cabling between the components. Advanced design techniques make real-time features possible, such as the scrolling, multiple game pattern display. The Statesman Color Bingo System was specially designed with the operator in mind. For example, all system controls are placed on a single control panel. The Color Statesman will provide years of trouble-free service. However, if a problem should arise, our service personnel will provide timely response on repairs, spare parts and technical support.

This revised manual will guide you through unpacking, installation, programming, running games and sessions with easy-to-follow instructions and corresponding illustrations of the screen displays and console key sequences.

---

---

## ***Damage Action Process***

*Your Capitol Bingo Equipment contains delicate electronic equipment. It is imperative that you thoroughly inspect the contents of the package before accepting product delivery from the carrier.*

*In case of severe damage, refuse the equipment from the carrier. Contact your distributor or Arrow International for immediate replacement.*

*In case of damage, make a note on the bill of lading before accepting, take a photo of the damage, and keep the packaging to aid in recovering the amount of claim against the carrier.*

*If the product is damaged but acceptable, take a photo before and after unpacking as a record of the damage and contact the carrier's agent immediately for inspection. Be sure to obtain a copy of the inspection report for your records.*

*If these precautions are not taken, we cannot assist you in recovering the amount of the claim against the carrier.*

---

---

# Table of Contents

I.	Getting Started .....	5
A.	Unpacking .....	5
B.	Warranty Assurance .....	7
C.	Basic Controls .....	7
D.	Electrical Installation .....	7
E.	Flashboard Installation .....	7
F.	Optional Video Installation .....	8
G.	Optional Printer Installation .....	9
II.	Physical Installation .....	9
A.	Suggested Number of Flashboard Mounting Assemblies .....	9
B.	Wall Mounting Preparation for Flashboard(s) .....	10
C.	Wall Mounting Instructions .....	10
D.	Ceiling Mounted Flashboards .....	11
E.	Flashboard Stand (optional) .....	11
III.	System Programming .....	12
A.	Keypad Programming Reference Guide .....	12
B.	System Setup .....	14
C.	Creating a Game Pattern .....	15
D.	Creating a Session .....	19
E.	Quick Reference Guide - Programming an Individual Game Pattern .....	20
F.	Quick Reference Guide - Prog. an Automatic Complex Game Pattern .....	21
G.	Quick Reference Guide - Prog. a Manual Complex Game Pattern .....	22
H.	Quick Reference Guide - Programming a Session .....	23
I.	Pre-Programmed Game Patterns .....	24-27
J.	Operator's Game Pattern Worksheets .....	28-33
K.	Session Programming Worksheets .....	34-38
IV.	Running Individual Games and Sessions .....	39
A.	Playing the Bingo Game .....	39
B.	Manual Game .....	40
C.	Pre-Programmed Session .....	40
D.	Changing Pre-Programmed Game Data .....	42
E.	Canceling a Ball .....	42
F.	Verifying a Bingo .....	43
G.	Quick Reference Guide - Running a Manual Game .....	46
H.	Quick Reference Guide - Running a Session .....	46
I.	Quick Reference Guide - Verifying a Bingo .....	47
V.	Special Functions .....	48
A.	Testing the System .....	48
B.	Entering a Wild Number .....	48
C.	Tear Open Save and Recall .....	49
D.	Delete the Winning Pattern Shown on the Verifier Screen .....	49
E.	Game Recall (Resume Previous Game) .....	50
F.	Speed Bingo .....	50
G.	Printed Audit Trail and Summary of Balls Called with Optional Printer .....	51
H.	Time and Date Programming .....	52
I.	Changing the Ball Timer Mode .....	53
J.	Auto Call or Random-Number Generator (optional feature) .....	54
VI.	Service .....	55
A.	Cleaning your Statesman Color Bingo System .....	55
B.	Changing the Mixing Chamber Light Bulb .....	56
C.	Changing Light Bulbs in the Flashboard .....	56
D.	Servicing the Blower and Mixer Base Pan Assembly .....	59
E.	Troubleshooting .....	60
F.	System Power Requirements and Fusing .....	66
VII.	Wiring Diagrams .....	67-78
	Capitol Bingo Equipment Limited Warranty .....	79



# I. Getting Started

## A. Unpacking

Arrow International designed your Statesman Color Bingo System to have a distinctively attractive appearance, and we used careful manufacturing and assembly techniques to preserve this appearance. Each Color Statesman system is inspected for scratches, bumps or abrasions during packing, and is warranted to be free from defects.

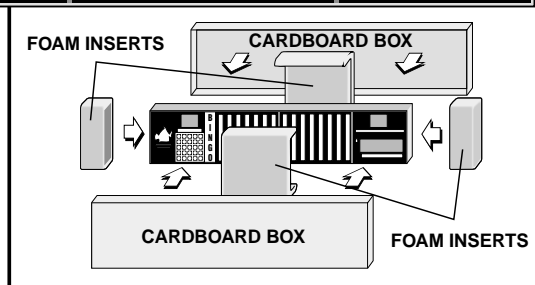
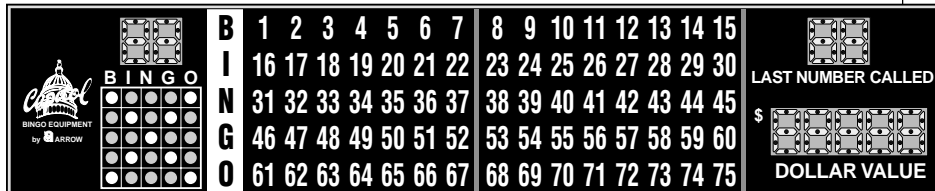

### 1. Flashboard

The flashboard is banded into a heavy cardboard enclosure with foam inserts at each end and in the middle. This carton is marked with various warning labels and stampings. Lay the carton flat, observing labels indicating which side is up.

Before opening, closely inspect the carton for evidence of shipping damage such as puncture holes, tears, and crushed edges or corners. Damage to the carton may alert you to damage to the flashboard. If damage is detected refer to the Damage Action Process section (p. 3) for procedures.

Use scissors to cut all straps. Carefully lift off the carton top. Cut the tape on the four corners of the carton bottom and lay the carton flaps down flat. Slide both ends and the top center foam pieces off to allow access to the flashboard. To prevent scratches, make sure the flashboard remains on cardboard prior to actual installation. Obtain assistance in setting the flashboard upright.

Do not destroy or discard carton materials until after final inspection and testing.

Inspect the flashboard to insure that all acrylic panels are in place and free of cracks or heavy scratches. Inspect the masonite panels for damage. If damage to your equipment is evident, or if you have problems in any of the above areas, contact your area distributor immediately for advice and refer to the Damage Action Process section (p. 3) for procedures.

*Caution: This flashboard weighs approximately 175 pounds. Use care and get assistance before unpacking and lifting. A minimum of two individuals is required for unpacking.*

*Note: Included with the flashboard is a 100 ft. data cable, flashboard mounting brackets, flashboard data cable adapter and a customer parts kit consisting of:*

*4- #1820 Light bulbs*

*2- 4 AMP Slo Blo 250V fuses*

*2- 3.2 AMP Slo Blo 250V fuses*

*Caution: This console weighs approximately 170 pounds - get assistance before lifting. A minimum of two individuals is required for unpacking.*

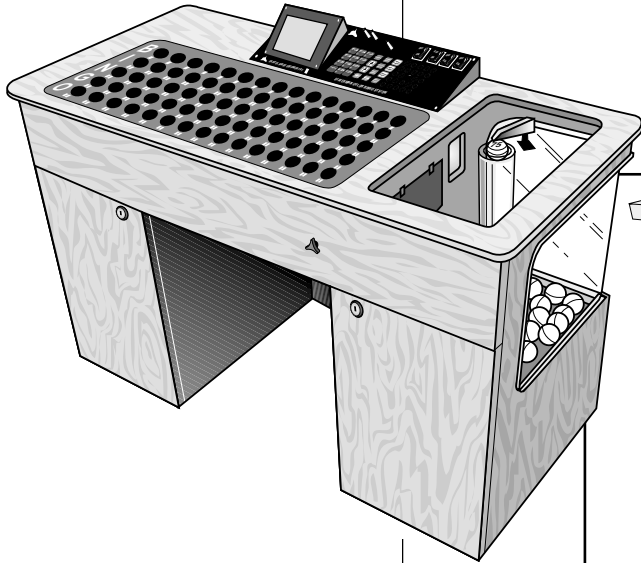

## 2. Console

The Statesman Color console is packed with foam protectors in a cardboard carton and is skid-mounted. Once again, check the carton for possible signs of damage. If damage is detected refer to the Damage Action Process section (p. 3) for procedures.

Use scissors to cut the straps from the skid only, taking care not to cut the straps protecting the console. With the help of at least one assistant, carefully lift the console from the skid and place it on solid flooring. Cut the remaining four straps from the console and remove the cardboard top.

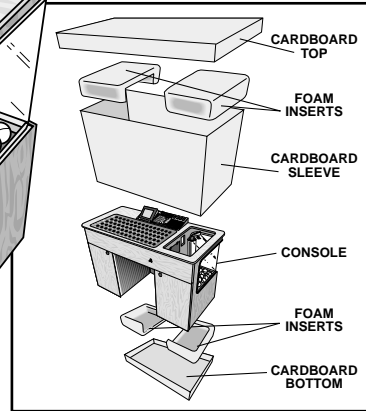

Remove the two foam protectors inside the top and slide the cardboard tube up and off the console. A minimum of two people are required to safely unpack the console. With one person

*Note: Do not destroy or discard carton materials until after final inspection and testing.*

lifting from the top of the ball-blower end and another individual grasping the two handles on the opposite end, raise the console up and out from the carton and foam inserts. Check that all casters are in place. Set unpacked console on solid flooring. Do not destroy or discard carton material until after final inspection and testing.

### SAMSON BALLS

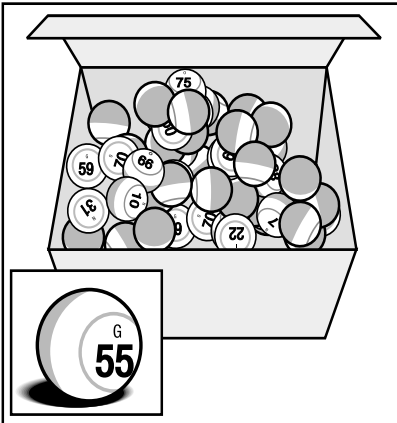

At this point you should inspect the console for shipping damage. All acrylic panels should be in place. Metal panels and their associated switches and parts should be operational. If problems are found in any of these areas, immediately contact your distributor for advice and refer to the Damage Action Process section (p. 3) for procedures.

The following can be found inside the left door of the console:

### 20 FT. DATA CABLE

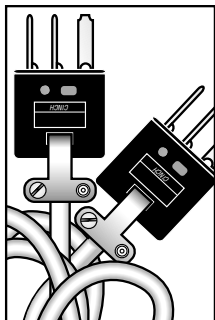

### PARTS KITS

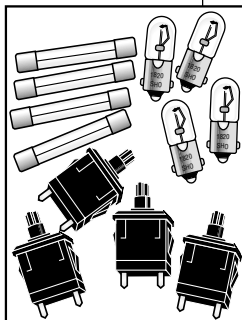

- (1) Set of superior quality Samson balls
- (1) Standard 20 ft. data cable (other lengths optional)
- (1) Customer parts kit, which includes:
  - (4) Low-voltage ball switches
  - (4) #1820 28V light bulbs
  - (2) .1 AMP MDL 250V fuses
  - (2) 6 AMP AGC/3AG 250V fuses

Open the box of Samson balls, check each ball for damage and insert each ball into its corresponding slot in the console ball tray. If a ball has a flat spot, immerse it in hot water. Usually the flat area will pop out. If it does not, contact your distributor for a replacement.

## B. Warranty Assurance

At this time, please verify the serial numbers located on the output panel inside the left compartment of the console and on the left side of the flashboard. Check them against those shown on the enclosed warranty card, please fill out all requested information and return the completed warranty card to Arrow International within 30 days of purchase along with proof of purchase date.

A second warranty card appears on the back cover of this manual. We suggest that you fill out this card and keep the information on hand for future reference.

## C. Basic Controls

1. Power - This is the ON/OFF switch for the onboard computer.
2. Lamp - This is the ON/OFF switch for the mixer-chamber lamp.
3. Blower - This is the ON/OFF switch for the ball-blower motor.
4. Mixer - This is the ON/OFF switch for the ball-mixer motor.
5. Contrast - This is used to adjust the contrast for the LCD graphic display panel (backlighting).
6. Volume - This is the volume adjustment for the audible beeper.

## D. Electrical Installation

1. Plug the bingo console and flashboards into any 110/120VAC 60HZ grounded power outlet.
2. Once the system has been completely setup, turn the "POWER" switches on. Use the other controls as needed.

## E. Flashboard Installation

1. The Statesman Color Bingo System is compatible with the following flashboards:
  - Capitol Access flashboard line.
  - Capitol aluminum extruded flashboard line.
  - Capitol 2001 system flashboards.  
(Refer p. 68 for flashboards older than Jan. 1991.)
  - Capitol Presidential system flashboards.  
(Refer p. 68 for flashboards older than Jan. 1991.)
  - Several models from other manufacturers.  
Please inquire for specifics.
2. Connections for regular Bingo flashboards are made with the console data output connectors labelled "BINGO."
3. Connections for Tear Open flashboards are made with the console data output connectors labelled "TEAR OPEN." All control of Tear Open flashboards is automatic.

*To validate your warranty, you must complete the enclosed warranty card and return it to Arrow International, Inc. within 30 days of purchase from your Capitol Bingo Equipment Distributor.*

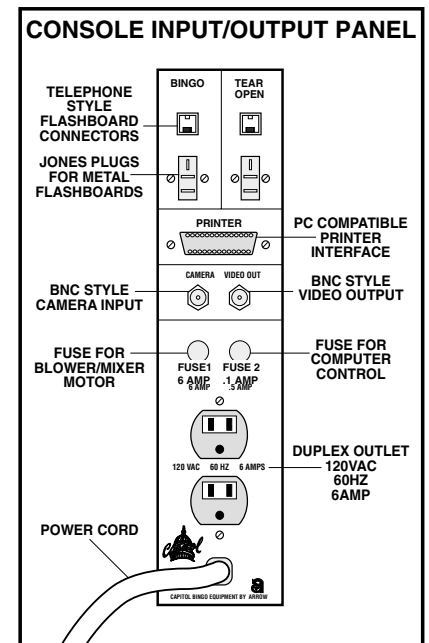

## FLASHBOARD DATA CONNECTIONS

**ALUMINUM  
EXTRUDED  
FLASHBOARD  
UPPER LEFT  
SIDE PANEL**

**METAL  
FABRICATED  
FLASHBOARD  
LEFT SIDE PANEL**



---

*Note: If not using a Tear Open flashboard, the Tear Open data outputs may be used for regular bingo flashboards.*

---

*Note: Refer to diagram D on p. 68 for required modifications on Presidential/2001 AR style flashboards.*

---

*Note: When installing any cable, install it in such a manner that it will not be subjected to undue wear and tear or create a traffic hazard.*

---

*Note: If utilizing Capitol Bingo Equipment video components please refer at this time to the Capitol Bingo Equipment Video Components Manual for further instructions.*

---

*Note: If using multiple monitors, run a cable from the BNC connector labelled "VIDEO OUTPUT" on the first monitor to the "VIDEO INPUT" on the subsequent monitor. Set all monitors to High Impedence with DC Restoration off, except for the last monitor, which is set to 75 ohm.*

---

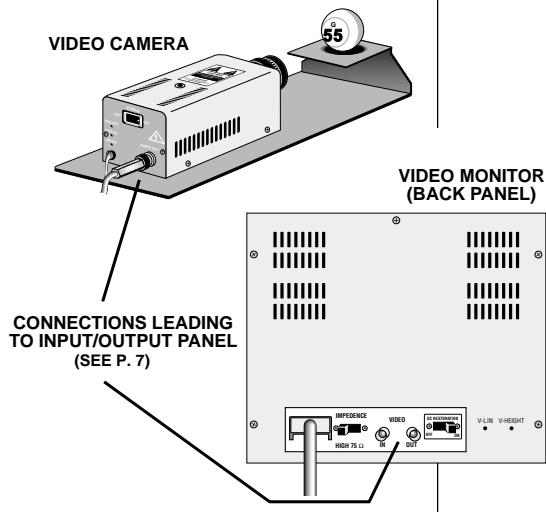

4. Install the flashboard data cable. When possible, we recommend using a one-piece cable avoiding splices, adapters and other mating devices. Wiring to the flashboard may be permanently installed using a wire mold. Or, where permanent installation is not possible, install the flashboard data cable through the walls and ceiling to an area where the console can be rolled in and easily connected with all data and power cables. Install it in such a manner that it will not be subject to undue wear and tear and will not create a traffic hazard. Avoid running the flashboard cable next to high-current lines such as smoke eaters, air conditioners, etc.

For metal fabricated style flashboards, plug the 3-pin male data connector into the lower connector marked "INPUT." For aluminum extruded-style flashboards, plug the data cable into the rear telephone jack on the left side of the flashboard marked "INPUT."

5. You may have an installation that requires hook up of more than one flashboard. In such an instance, the second and subsequent flashboards may be daisy chained by connecting the data cable to the "OUTPUT" connection on the first flashboard to the "INPUT" connection on the second flashboard, and so on. This allows virtually an unlimited number of Capitol Bingo flashboards to be added.

## F. Optional Video Installation

1. The BNC-type connector marked "CAMERA INPUT" is used with any camera having a standard composite video output. Cameras that are "TV ready" or have an RF video output are not compatible with this system. Use a high-quality RG 59U video cable with BNC connections, plug one end into the "CAMERA INPUT" connector on the video input panel which is located behind the ball catcher. Connect the other end to the "VIDEO OUTPUT" connector on the camera. The RCA jack labeled DC power is just a feed through for DC powered cameras. It may, at time of order, optionally be wired for Arrow color camera.
2. The BNC-type connector marked "VIDEO OUTPUT" can be used with any composite video monitors. Use a high-quality RG 59U video cable with BNC connectors, plug one end into the "VIDEO OUTPUT" connector located in the left compartment of the console and the other end into the "VIDEO INPUT" connector on the monitor.

If your organization has chosen to use televisions instead of monitors, an RF modulator is required. Contact your distributor for a copy of the Capitol Bingo Equipment Video Components Manual and/or advice.

**G. Optional Printer Installation**

1. The connector marked "PRINTER" is a standard IBM® compatible dot matrix printer interface. Simply plug in any PC-compatible printer power cord and printer signal cable (please refer to the printer operating manual for proper instructions) and you are ready to run. Always keep the printer set to "ON LINE" to prevent any errors.
2. When using your printer, always keep paper installed in the printer and have an adequate paper supply on hand. While an "out of paper" error will not lock-up the system, you will lose valuable game log information if the printer runs out of paper and new paper is not inserted.
3. If you do not use the printer, either turn the printer power off or unplug the printer from the printer signal connector.
4. Refer to the owner's manual of your specific printer for additional information.

**9-PIN DOT MATRIX PRINTER**

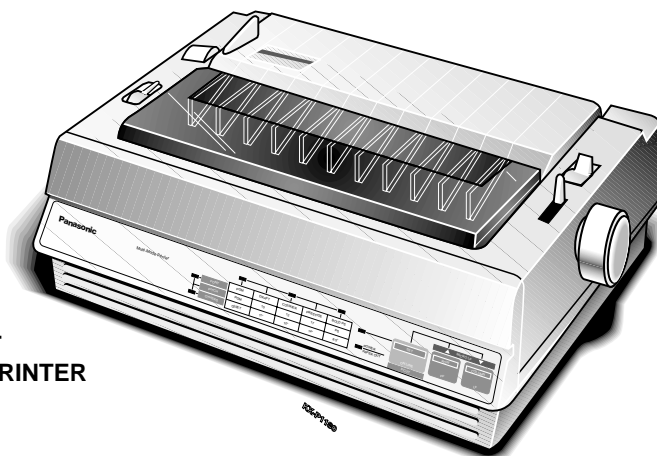

**Note: It is recommended to have the printer "on line" before powering up the console.**

**PRINTER CABLE**

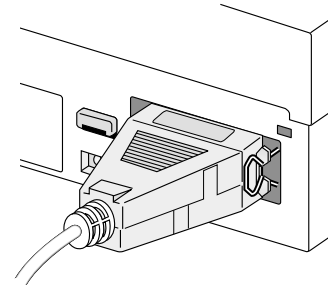

**Caution: Before attempting any installation, have a qualified, licensed and bonded rigger or electrician verify the type of installation. In many cases, the local building inspector may require a permit as well as an inspection of the site for structural stability.**

**II. Physical Installation**

**A. Suggested Number of Flashboard Mounting Assemblies**

<b>SUGGESTED NO. OF FLASHBOARD MOUNTING ASSEMBLIES</b>				
	<b>PART NO.</b>	<b>NUMBERS ONLY</b>	<b>NO. &amp; GAME INDICATOR</b>	<b>NO., GAME INDICATOR &amp; DOLLAR VALUE</b>
2" Wall Mount	45253	2	2	3
J Bracket	415805	2	2	3
EyeBolt	46515	2	2	3
4" Wall Mount	45254	3	3	4
J Bracket	415805	3	3	5
EyeBolt	46515	3	3	4



*Caution: Do not suspend the flashboards using the handles. The handles are to be used for handling purposes only.*

*Note: When choosing the location for mounting your flashboard(s), consider not only visibility but protection against tampering, vandalism and pedestrian traffic. We suggest your flashboard at least 7' above the floor.*

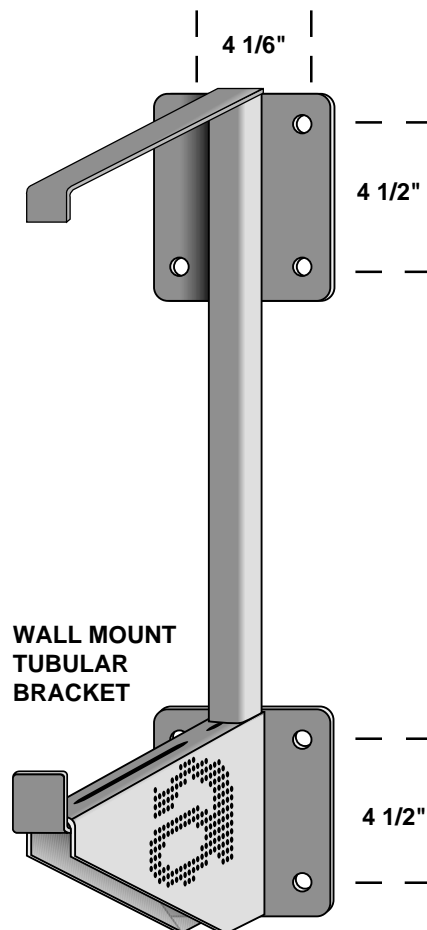
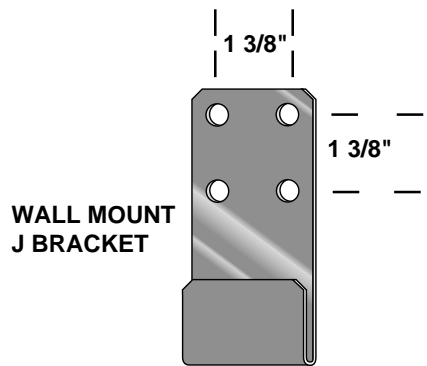

**B. Wall Mounting Preparation for Flashboard(s)**

Before attempting to mount any flashboard to the wall, you must first determine the type of wall construction. For hollow walls, we recommend that the flashboard mounting brackets be fastened directly into wall studs. For concrete, brick and cinder-block construction, the mounting brackets should be fastened using a bolt and anchor method (moly bolt). If other methods of wall construction are used, consider ceiling mounting or consult the Capitol Bingo Equipment Service department for advice.

**1. 2" and 4" aluminum extruded flashboards**

Use J-brackets or tubular brackets mounted to either a hollow wall or masonry (solid concrete or cinder-block construction) wall. Alternatively, flashboards may be mounted to the ceiling. Optional eyebolts are available upon request.

**C. Wall Mounting Instructions**

For hollow-wall construction use 3/8" x 3 1/2" lag bolts. Fasten brackets directly into wall studs. For masonry construction, use a 3/8" or larger lag-screw expansion shield with suitable-length lag screw.

**1. Wall-Mount J Bracket**

(2" & 4" aluminum extruded flashboards)

Supplied with the 4" aluminum extruded dollar value flashboard are five J-shaped wall brackets (other flashboards may vary). Each bracket has four clearance holes for 3/8" bolts. Choose a height that allows for easy viewing and mark the location on the wall. Then, measure in 8 1/2" and 9 7/8" from each end of the flashboard and mark the vertical center lines. Next, from the top of the flashboard, measure up 2" and 3 3/8" from the horizontal center lines.

Before drilling any holes, check for possible electrical or plumbing interference behind the mounting holes and make sure that the flashboard is level from side to side. Next, space any additional brackets equally between the previous brackets and locate the mounting holes, again checking for level. Drill the proper clearance holes for the method of mounting appropriate for your wall as described above.

**2. Tubular Bracket (optional)**

(2" and 4" aluminum extruded and 4" fabricated flashboards)

Choose the proper height for easy viewing and mark the location on the wall. This mounting bracket supports the flashboard from the bottom and may be used to mark the mounting holes. Locate brackets 9" from each end; make sure the brackets are level; and check for possible electrical or plumbing interference behind the mounting holes. Equally space the remaining brackets between the end brackets insuring that all supporting surfaces are level. Drill the proper clearance holes for the mounting method appropriate for your wall.

**D. Ceiling Mounted Flashboards**

In any ceiling mount application, the chain or wire must be attached to the steel building frame or girder. In addition, check with the local building inspector for local codes governing weight restrictions and mounting methods.

There are two different methods for suspending these flashboards from the ceiling.

**1. Chain**

Use a high-quality  $3/8$ " minimum-diameter chain link made of high-strength alloy steel grade 80 or its equivalent. Bolt the chain together with a  $3/8$ " 18 NC  $1\ 3/4$ " bolt with two flatwashers, a lockwasher and a hex nut.

**2. Cable**

Use a high-strength  $1/8$ " minimum-diameter 7x19 strand steel aircraft cable or its equivalent and appropriate cable clamps.

*Caution: Do not suspend the flashboards using the handles. The handles are to be used for handling purposes only.*

*Note: See Capitol Bingo Equipment 8" & 12" Aluminum Extruded Flashboard Manual for additional information on these products.*

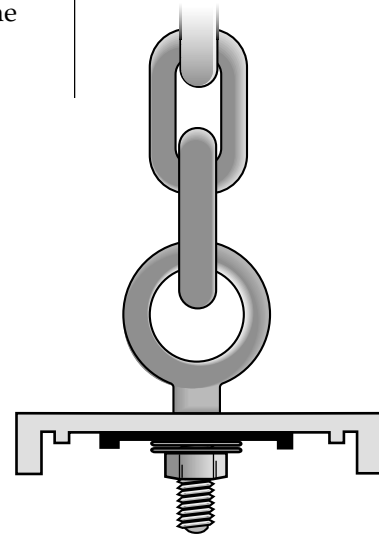

**EYEBOLT FOR CHAIN MOUNT (ARROW PART #46515)**

FLASHBOARDS	EYEBOLT LOCATIONS MEASURED FROM LEFT END			
	22"	46"	94"	118"
4" Dollar Value	22"	46"	94"	118"
4" Game Indicator	22"	38 $3/4$ "	55 $1/2$ "	72 $1/4$ "
4" Numbers Only	17"	49"	76"	
2" Dollar Value	18"	36"	48"	
2" Game Indicator	18"	47"		
2" Numbers Only	12"	44"		

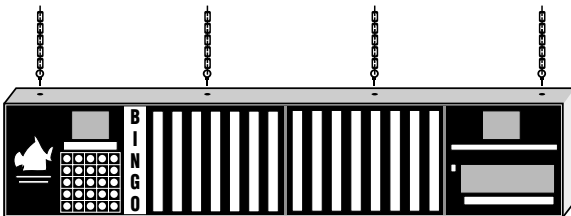

**E. Flashboard Stand (optional)**

A flashboard stand allows for easy mobility and storage of your flashboard. Capitol offers a triple upright flashboard stand for the 4" dollar-value-style flashboards and a double upright flashboard stand for all other 4" and 2" flashboards. These stands may be ordered through your distributor.

Please refer to the Arrow International Inc./Capitol Bingo Equipment catalog for other optional equipment and accessories.

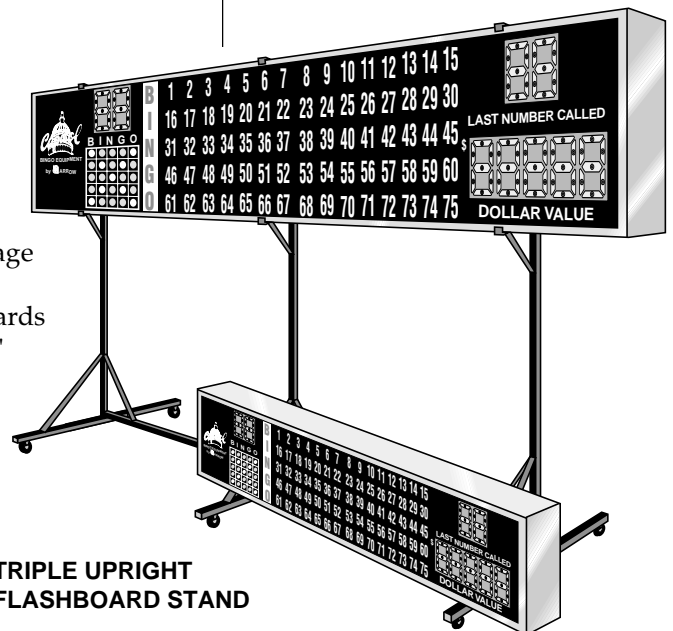

**TRIPLE UPRIGHT FLASHBOARD STAND**

# III. System Programming

## A. Keypad Programming Reference Guide

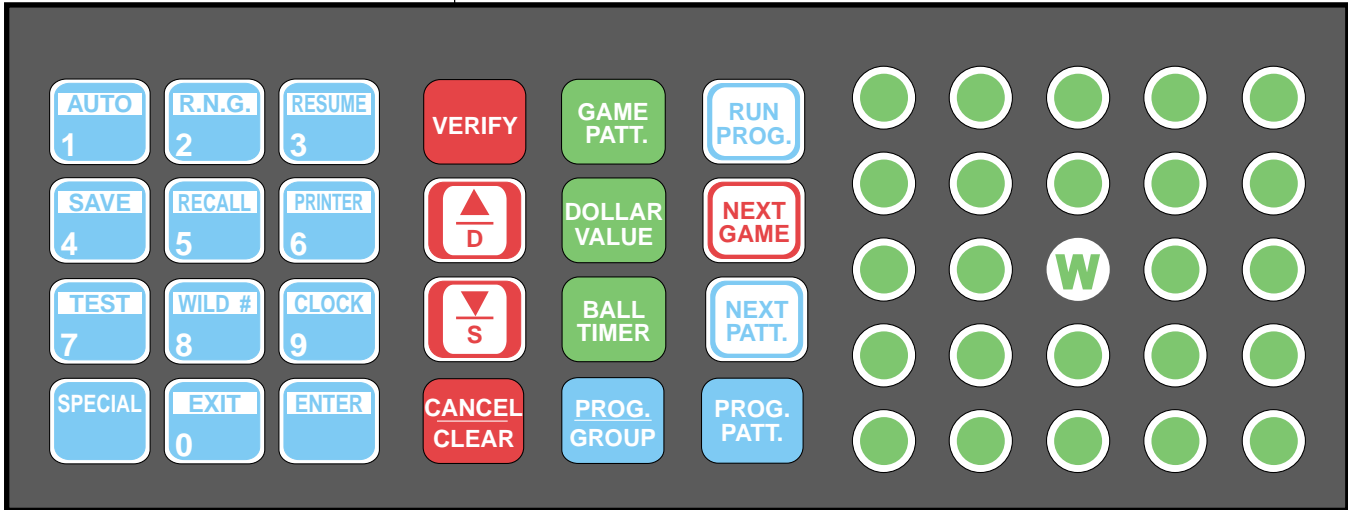

FUNCTION	KEY SEQUENCE
Clear All Memory	Special — Cancel/Clear — W — 2 — 4 — 6 — 4 — 6
Select Constant Timer Mode	Special — Auto — Enter: (Alternates w/ Ball-Act. Timer)
Select Ball Activated Mode	Special — Auto — Enter: (Alternates with Constant Timer)
Random Number Generator (optional)	Special — RNG — (number of balls to be called) — Enter
Save Tear Open Game	Special — Save — Enter
Recall Tear Open Game	Special — Recall — Enter
Test Flashboards	Special — Test
Wild-Number Entry	Special — Wild # — (menu options) — Special — Exit
Set Time	Special — Clock — Enter — (hour) — Enter — (minutes) — Enter
Set Date	Special — Clock — D — (month) — Enter — (day) — Enter — (year) — Enter
Leave Session or Resume Manual Mode	Special — Exit — Enter: (to leave session) Special — Exit — Cancel/Clear: (to resume current session)
Cancel a Call	Cancel/Clear — (number of ball to be cancelled) — Enter
Instant Game Pattern	Game Patt. — Enter — (game pattern keys) — Enter
Resume Prev. Game (ver. 1.4 and above)	Special — Resume: (only in auto mode)

**Keypad Programming Reference Guide Continued**

FUNCTION	KEY SEQUENCE
Verify:	
Standard Face	Verify — (free-space number) — Enter
Dab All Face	Verify — Special — 2 — (free-space number) — Enter
Mini 75	Verify — Special — 3 — (free-space number) — Enter
Custom	Verify — Special — 4 — (free-space number) — Enter
Win Tally	Verify — W — Enter: (default # of winners) Verify — W — (number of winners)—Enter: (override default)
Program Session	Prog./Group — (session number) — Enter — (game number) — Enter
Game Pattern Select	Game Patt. — (game pattern number) — Enter
Dollar Value	Dollar Value — (dollar value) — Enter
Ball Timer	Ball Timer — (number of seconds) — Enter
Next Game	Next Game — Enter
Leave Program Session	Special — Exit — Enter
Next Pattern	Next Pattern
Run Pre-Programmed Session	Run Prog. — (session number) — Enter — (game number) — Enter
Program Individual Pattern	Prog. Patt. — Enter — (game pattern number) — Enter — [(game pattern keys) — Next Patt.] — Prog. Patt.
Program Manual Complex Game Pattern	Prog. Patt — Special — (Game pattern number) — Enter [(game pattern keys) — Next Patt.] — Prog. Patt.
Program Automatic Complex Game Pattern	Prog. Patt. — Prog./Group — (game pattern number) — Enter — [(game pattern keys) — Next Patt.]— Prog. Patt. — number of building block multiples— Enter

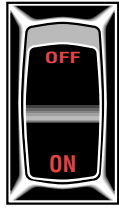

POWER



Note: This is only required for initial installation or when changing configurations.



Note: When the flashboard is turned on, the system will automatically perform a sequential self test.



### B. System Setup

- 1. Turn the "POWER" switch on.

The display will read:

STATESMAN SYSTEM  
BY CAPITOL BINGO  
EQUIPMENT REV CS4.5  
COPYRIGHT 1992,93  
  
PRESS 'ENTER' TO  
START THE GAME OR  
USE THE 'RUN PROG'  
TO START A BINGO  
SESSION

- 2. Press the "ENTER" key.

- 3. Press the "SPECIAL" key, followed by the "S" key.

The display will read:

\*\* SETUP SYSTEM \*\*  
ENTER PASSWORD:

- 4. Enter the system setup password "2" — "4" — "6" — "4" — "6", using the numeric keypad.

The display will read

PRESS NUMBER KEY TO  
SELECT OPTION (1:9)

- 5. Pressing #1 selects either the 75 or 90 number bingo console operation. *This option must be selected for proper console installation.* Press the "ENTER" key for 75 number or the "S" key for 90 number.

- 1. TRAY SIZE (75/90#)
- 2. VERIFIER OPERATION
- 3. VERIFY BK CONSOLE
- 4. CONFIG GAME IND. FB
- 5. SET RNG OPERATION
- 6. VERIFY W/LAST BALL
- 7. VIEW CURRENT SETUP
- 8. DV FB (LAST#/GAME#)
- 9. EXIT SETUP

ENTRY:

- 6. Pressing #2 selects the Capitol style verifier operation. The verifier must be plugged into a Capitol Bingo Equipment 2001 / Presidential console in order to operate correctly when #2 is selected. **Note: This option is for use as a verifier only.**

- 7. Pressing #3 selects the BK style verifier operation. The verifier must be plugged into a BK console in order to operate correctly when #3 is selected. Consult Capitol Bingo Equipment Service Department for additional information. Some systems may require the use of an adapter cable.

- 8. Pressing #4 will allow you to specify the type of numeric display shown on the game indicator style flashboard. The following menu will be shown, make your selection by typing the appropriate number and follow with the "ENTER" key:
  - 1. FOR TOTAL NUMBER OF BALLS CALLED
  - 2. GAME NUMBER
  - 3. LAST BALL CALLED

- 9. Pressing #5 will bring up the following menu:  
Note: If the system prompts you with a message "This option not available" Press any key to return. Consult your distributor to order this option if it is legal in your jurisdiction.



ENTER RNG PASSWORD:

- a. Press "2" — "2" to select option.
- b. Press the "ENTER" key.

10. Pressing #6 will allow you to select the verify on last ball called option. Press the "ENTER" key to mandate that a valid bingo must contain the last number called. Pressing any other key does not restrict the verification to include the last number called.
11. Pressing #7 will display the current system setup for the ball tray size; operation; configuration; call mode and verification options. You can return to the previous screen by pressing any key.
12. Pressing #8 will allow you to display either Last Number Called or Game Number on the Dollar Value Style Flashboards. Press the "ENTER" key to select Game Number or any other key to display Last Number.
13. Pressing #8 will return you to the manual game screen.

**C. Creating a Game Pattern**

**1. Programming an Individual Game Pattern (1-45 combinations)**

(Software version CL 1.3 or lower is limited to 30 combinations.)

- a. Press the "PROG. PATT." key.

The display will read:

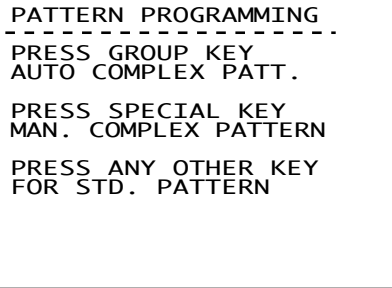

- b. Press the "ENTER" key.

The display will read:

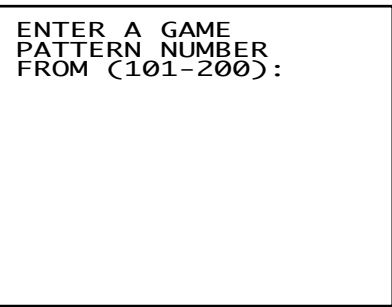

- c. Select a game pattern number from 101 to 200, using the numeric keypad, then press the "ENTER" key. **Refer to note.**

The display will read:

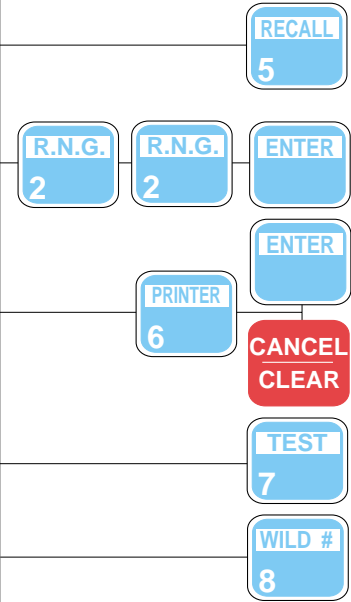
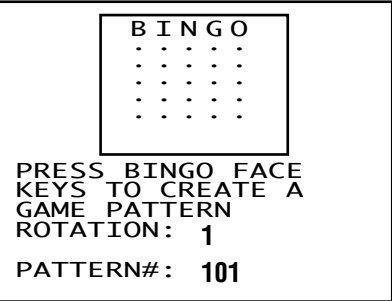

*Note: It is best to clear the memory before programming the initial time.*

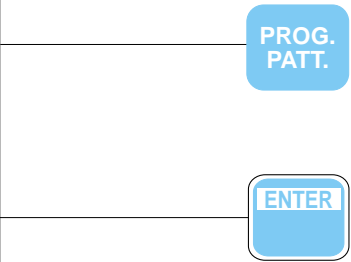

*Note: You may program game patterns numbered from 101-240 only. (Software version CL 1.3 or lower is limited to 230 game patterns.) patterns 1-100 are already programmed for you. (Refer to the diagrams and descriptions for patterns 1-100 starting on p. 24.)*



*Note: Bold numbers on future screens are for example only.*

*Note: Care must be taken when designing progressive game patterns. It is very important that statistics are used to determine the typical number of balls required to bingo out on a particular game pattern. Progressive game patterns must be arranged from the least number of balls required to bingo out, to the most required.*

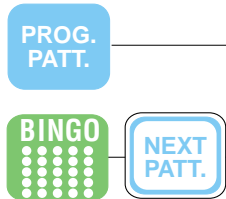

*Note: If you press the wrong button when creating the bingo face on the keypad, simply press the same button again to erase your mistake.*

- d. Design your individual game pattern using the game pattern switches on the control panel keypad.  
If you wish to play with more than one valid bingo pattern, press the "NEXT PATT." key and design your next game pattern. This may be repeated for up to 45 combinations. (Software version CL 1.3 or lower is limited to 30 combinations. **Refer to note.**)
- e. Press the "PROG. PATT." key to save the new game pattern.
- f. Record your newly created game pattern on your game pattern worksheets (pp.28-33) for future reference.
- g. Program session (refer to section D, p. 19, Creating a Session), or enter the game pattern and begin the game (refer to section IV, p. 39, Running Individual Games and Sessions).

## 2. Programming an Automatic Complex Pattern (up to 400 combinations)

(Software version CL 1.3 begins with game pattern #31.)

Automatic programming of a complex game pattern utilizes modular building blocks of game patterns that can be grouped together by the onboard computer. The computer mathematically calculates all potential winning game patterns. For example: entering in horizontal lines, vertical lines, diagonal lines and four corners can allow the user to create a double, triple or quadruple standard bingo.

- a. Press the "PROG. PATT" key.

The display will read:

```
PATTERN PROGRAMMING
-----
PRESS GROUP KEY
AUTO COMPLEX PATT.

PRESS SPECIAL KEY
MAN. COMPLEX PATTERN

PRESS ANY OTHER KEY
FOR STD. PATTERN
```

- b. Press the "PROG. GROUP." key

The display will read:

```
WARNING: GROUP FCTN.
WILL ERASE EXISTING
PROGRAMMED PATTERN

ENTER A GAME
PATTERN NUMBER
FROM (201-240)
```

- c. Enter a game pattern number from (201-240) using the numeric keypad. (Software version CL 1.3 is limited to 230 game patterns).

A warning message will appear on the screen alerting you that the group function will erase any existing programmed patterns.

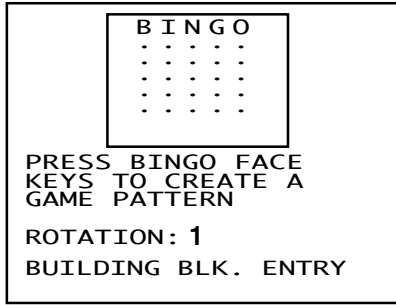

d. Press the "ENTER" key.

The display will read:

e. Design your individual game pattern using the game pattern switches on the control panel keypad.  
**Refer to note.**

f. Press the "NEXT PATT. key

g. Create the next modular game pattern building block.  
A maximum of 28 modular game pattern building blocks are allowable for a double bingo and a maximum of 14 modular game pattern building blocks are allowable for a triple bingo and a maximum of 11 for a quadruple bingo.

h. Press the "PROG. PATT. key.

The display will read:

i. Enter the number of building blocks multiples to group using the numeric keypad.

j. Press the "ENTER" key.

The display will read:

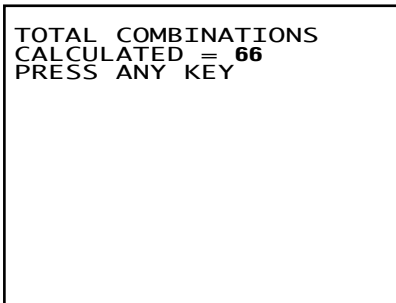
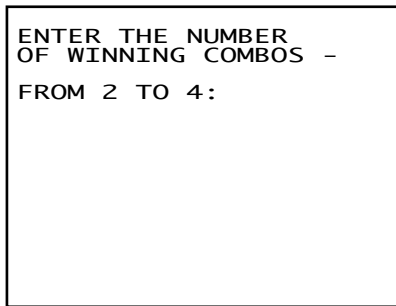

If the total number of combinations exceeds 400 a warning message will be displayed and the system will not accept your entry as a valid game pattern.

k. Press the "ENTER" key.

l. Record your newly created game pattern on your game pattern worksheets (pp.28-33) for future reference.

The complex game pattern feature may also be used as a quick way to program certain single patterns. After entering in the first modular building block press the "PROG. PATT." key and then the "ENTER" key. The console will shift and rotate that pattern for you, showing all the individual possibilities.



*Note: If you press the wrong button when creating the bingo face on the keypad, simply press the same button again to erase your mistake.*



*Note: Fill in all building blocks with a game pattern making sure not to leave any blanks between game pattern rotations. Exit modular game pattern entry at the last rotation programmed.*



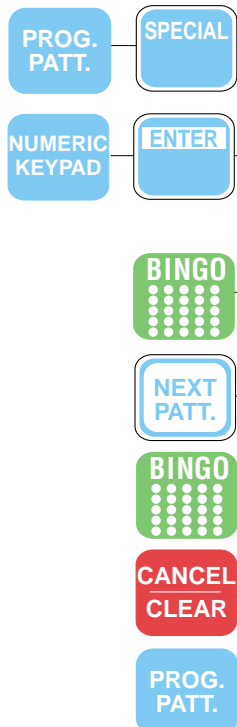

### 3. Programming a Manual Complex Game Pattern

This feature can be used to create up to 400 game pattern combinations without overlap or to edit existing complex game patterns.

- a. Press the "PROG. PATT" key.
- b. Press the "SPECIAL" key.
- c. Enter a game pattern number using the numeric keypad (201-240).
- d. Press the "ENTER" key.
- e. Design your individual game pattern using the game pattern switches on the control panel keypad. **Refer to note.**
- f. Press the "NEXT PATT." key.
- g. Create your next game pattern using the game pattern keypad. Follow each entry with the "NEXT PATT." key to enter up to a maximum of 400 game patterns.  
  
If the desired game pattern is incorrect, press the "CANCEL/CLEAR" key to erase the combination.
- h. Press the "PROG. PATT." key to save the new game pattern.
- i. Record your newly created game pattern on your game pattern worksheets (pp. 28-33) for future reference.

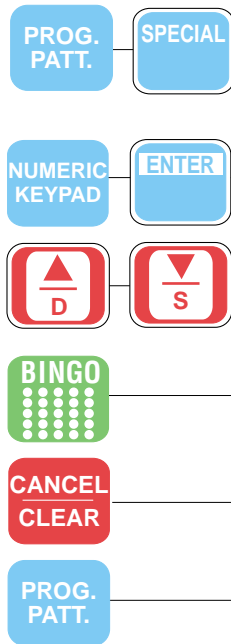

### 4. Reviewing/Editing a User Pre-Programmed Complex Game Pattern

- a. Press the "PROG. PATT" key.
- b. Press the "SPECIAL" key.
- c. Enter a game pattern number using the numeric keypad (201-240).
- d. Press the "ENTER" key.
- e. Use the "D" or the "S" key to scroll through the previously pre-programmed complex game patterns.
- f. To modify an existing game pattern, utilize the game pattern keypad to toggle each indicator on or off.  
  
To eliminate a game pattern simply turn off each indicator. To erase an existing pattern, press the "CANCEL/CLEAR" key.
- g. Press the "PROG. PATT." key.

*Note: If you press the wrong button when creating the bingo face on the keypad, simply press the same button again to erase your mistake.*

## D. Creating a Session (Editing Session)

This system allows you to program **up to 20 sessions**. Each session allows you to program up to **50 games**. For each game in a session, you may program up to **5 different game patterns, dollar values and ball timer values** to be played on the same card. This is also called a "Progressive Game."

```
PLEASE ENTER A
SESSION NUMBER
FROM 1-20:
```

1. Turn the "POWER" switch on.
2. Press the "ENTER" key.
3. Press the "PROG./ GROUP" key.

The display will read:

```
PLEASE ENTER A
SESSION NUMBER
FROM 1-20: 1
PLEASE ENTER A
GAME NUMBER
FROM 1-50:
```

4. Enter a session number (1- 20) using the numeric keypad. If you are programming a new session, enter "1" to begin with the first session.
5. Press the "ENTER" key.

The display will read:

```
SESSION: 1 GAME: 1
PATT.  $$$ VAL  TIMER
>1.   |  0   0   0
2.   |  0   0   0
3.   |  0   0   0
4.   |  0   0   0
5.   |  0   0  180
```

6. Enter a game number (1-50) using the numeric keypad. If you are programming a new session enter "1" to begin with the first game in that session.
7. Press the "ENTER" key.

The display will read:

8. Press the "GAME PATT." key.

Using the numeric keypad enter a game pattern number from either the built- in list (1-100) or from patterns you have created (101- 240). (Software version CL 1.3 is limited to 230 game patterns.)

9. Press the "ENTER" key.
10. Press the "DOLLAR VALUE" key.
11. Enter the "DOLLAR VALUE" data by pressing the corresponding key(s) on the numeric keypad. For example: To select a dollar value of \$50, press "DOLLAR VALUE", press "5", then "0", and then the "ENTER" key.
12. Press the "ENTER" key.

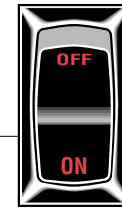

POWER

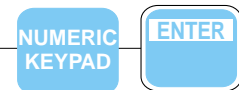
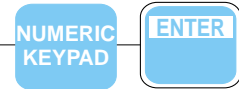
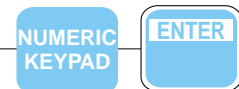
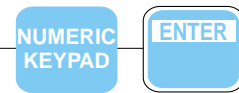

*Note: If you are programming a progressive game, enter all pertinent game information for the first game and then press the "NEXT PATT." key and return to step 8.*



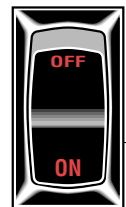
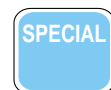

*Note: If you press the wrong button when creating the bingo face on the keypad, simply press the same button again to erase your mistake.*

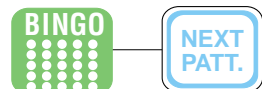

*Note: If entering a game pattern with up to 45 multiple winning patterns, all possible winning combinations must be entered at this time. For game patterns with more than 45 multiple winning game patterns, please refer to Section F & G Programming a Complex Game Pattern (p.16)*

13. Press the "BALL TIMER" key.

14. Enter the ball timer interval using the numeric keypad.  
For example: To select a ball timer interval of 15 seconds, press "BALL TIMER", enter "1" then "5", followed by the "ENTER" key.

15. Press the "ENTER" key.

16. Program additional games (up to 50) for that session by pushing the "NEXT GAME" key and continuing, starting with step #8.

The "S" key may be used to scroll down to your previous game when programming while the "D" key may be used to scroll up.

17. After completing your last entry, press the "SPECIAL" key followed by the "EXIT" key to save the program and return to the manual mode. Always exit at last user programmed game.

Once the session is programmed, it is retained in memory and may be changed at your discretion

### E. Quick Reference Guide - Programming an Individual Game Pattern

1. Turn the "POWER" switch on.
2. Press the "ENTER" key.
3. Press the "PROG. PATT." key.
4. Press the "ENTER" key to program individual game pattern(s).
5. Enter a game pattern number between 101-200.
6. Press the "ENTER" key.
7. Using the BINGO face keypad, type in the desired game pattern. **Refer to note.**
8. Press the "NEXT PATT." key to enter up to 45 possible winning game pattern combinations.
9. Using the BINGO face keypad, type in the next desired pattern. **Refer to note.** (Repeat steps #8 and #9 until the desired number of game patterns have been programmed.)
10. Press the "PROG. PATT." key to save the created game pattern(s).
11. Record your newly created game pattern(s) on your game pattern worksheets (pp. 28-33) for future reference.
12. To view or review previously programmed game patterns,

press "GAME PATT." key followed by game pattern number using the numeric keypad and then following with the "ENTER" key.

EXAMPLE: Creating a "CRAZY T" multiple-win pattern.

- a. Press the "PROG. PATT." key.
- b. Press the "ENTER" key.
- c. Enter a game pattern number between 101-200 using the numeric keypad.
- d. Press the "ENTER" key.
- e. Press in "┐" pattern on the BINGO face keypad.
- f. Press the "NEXT PATT." key.
- g. Press in "└" pattern on the BINGO face keypad.
- h. Press the "NEXT PATT." key.
- i. Press in "┌" pattern on the BINGO face keypad.
- j. Press the "NEXT PATT." key.
- k. Press in "└" pattern on the BINGO face keypad.
- l. Press the "PROG. PATT." to save the game pattern.

#### F. Quick Reference Guide -Programming an Automatic Complex Game Pattern

1. Turn the "POWER" switch on.
2. Press the "ENTER" key.
3. Press the "PROG. PATT." key.
4. Press the "PROG. GROUP" key.
5. Enter a game pattern number between 201-240 using the numeric keypad.
6. Press the "ENTER" key.
7. Enter in the first modular game pattern building block using the game pattern keypad.
8. Press the "NEXT PATT." key.
9. Continue entering the building blocks (steps #7 & #8) until complete. **Refer to note.**

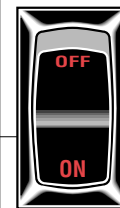
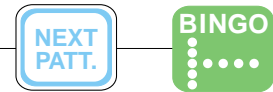
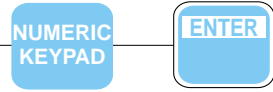
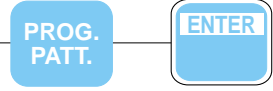

POWER

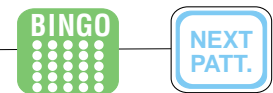

*Note: You may program up to 28 building blocks for a double, 14 building blocks for a triple and 11 building blocks for a quadruple bingo.*

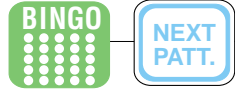
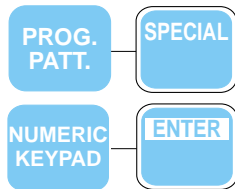
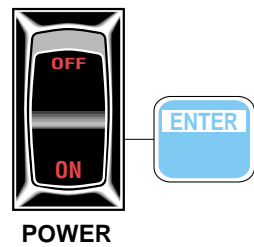
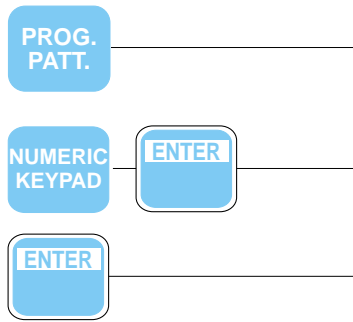

10. Press the "PROG PATT." key.
11. Press "2" for a double, "3" for a triple or "4" for a quadruple bingo.
12. Press the "ENTER" key to calculate potential winning game pattern combinations.
13. Press the "ENTER" key to return to the manual game screen.
14. Record your newly created game pattern(s) on your game pattern worksheets (pp. 28-33) for future reference.
15. To view or review previously programmed game patterns, press the "GAME PATT." key followed by the game pattern number using the numeric keypad then follow with the "ENTER" key.

### G. Quick Reference Guide -Programming a Manual Complex Game Pattern

1. Turn the "POWER" switch on.
2. Press the "ENTER" key.
3. Press the "PROG. PATT. " key.
4. Press the "SPECIAL" key.
5. Enter a game pattern number between 201-240 using the numeric keypad.
6. Press the "ENTER" key.
7. Enter in the first game pattern using the game pattern keypad.
8. Press the "NEXT PATT." key.
9. Continue entering the game patterns followed by the "NEXT PATT." key (steps #7 & #8) until complete. **Refer to note.**
10. Press the "PROG. PATT." key to save your newly created game pattern(s).
11. Record your newly created game pattern(s) on your game pattern worksheets (pp.28-33) for future reference.
12. To view or review previously programmed game pattern(s), press the "GAME PATT." key followed by the game pattern number using the numeric keypad, then follow with the "ENTER" key.

*Note: If entering a game pattern with multiple winning patterns, all possible winning combinations must be entered at this time. (Up to 400 winning game patterns.)*

## H. Quick Reference Guide - Programming a Session

1. Turn the "POWER" switch on.
2. Press the "ENTER" key.
3. Press the "PROG./GROUP" key.
4. Type in your desired session number between 1-20 using the numeric keypad. If you are programming a new session, enter "1" to begin with the first session.
5. Press the "ENTER" key.
6. Type in your desired game number between 1-50 using the numeric keypad. If you are programming a new session, enter "1" to begin with the first game in that session.
7. Press the "ENTER" key.
8. Press the "GAME PATT." key.
9. Type in a game pattern number from 1-240 using the numeric keypad.
10. Press the "ENTER" key.
11. Press the "DOLLAR VALUE" key.
12. Type in your payout using the numeric keypad (i. e. for a \$50.00 payout, type "5" - "0")
13. Press the "ENTER" key.
14. Press the "BALL TIMER" key.
15. Type in the desired time interval between the calling of a ball from 1-99 using the numeric keypad. (i. e. for 15 seconds type "1" - "5".)
16. Press the "ENTER" key.
17. If you are programming a progressive game (one that has more than one game pattern, payout and/or ball timer ), all of this information must be entered now. Go back to step #8 and continue until all game information is programmed.
18. Press the "NEXT GAME" key to program the next game in your session. Continue starting with step #8 for each game in your session.
19. Press the "SPECIAL" key to save your programming.
20. Press the "EXIT" key to exit the session and return to the manual game screen.

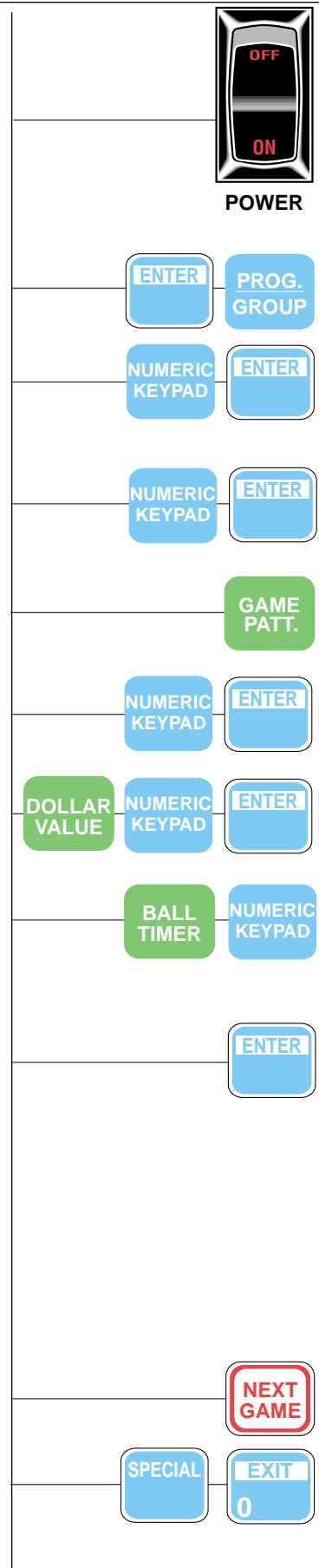

I. Color Statesman Pre-Programmed Game Patterns 1-25

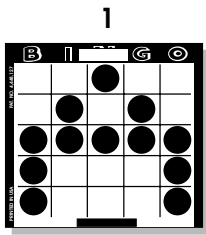

Letter A

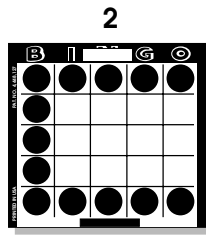

Letter C

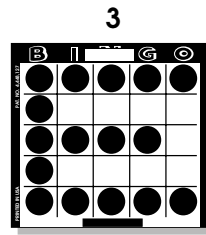

Letter E

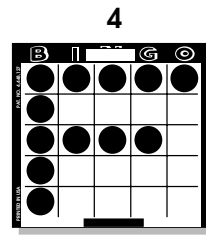

Letter F

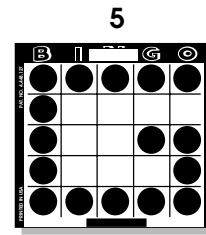

Letter G

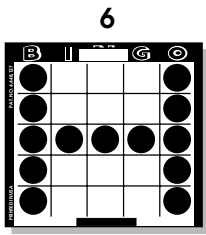

Letter H

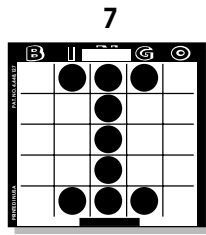

Letter I

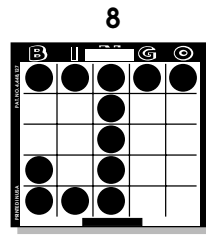

Letter J

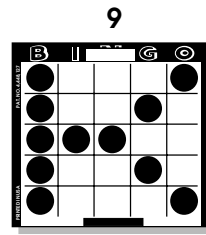

Letter K

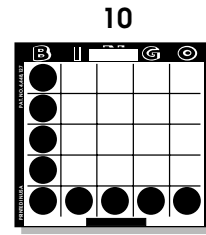

Letter L

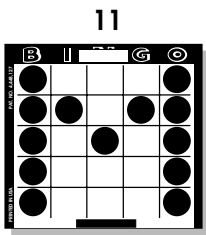

Letter M

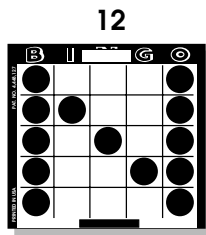

Letter N

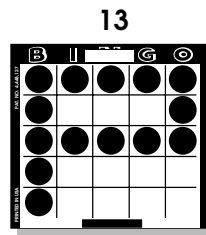

Letter P

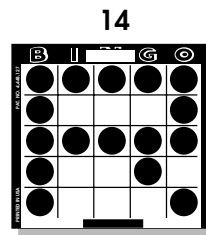

Letter R

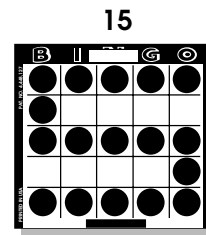

Letter S

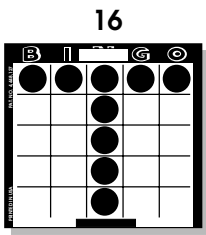

Letter T

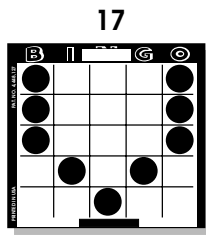

Letter V

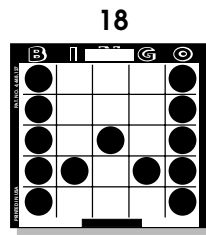

Letter W

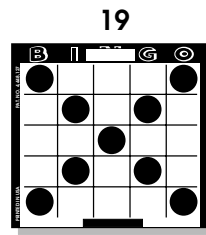

Letter X

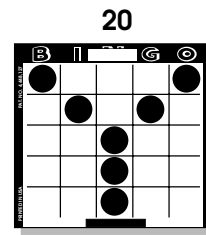

Letter Y

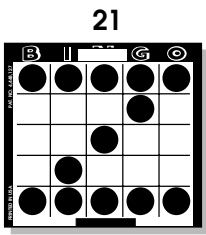

Letter Z

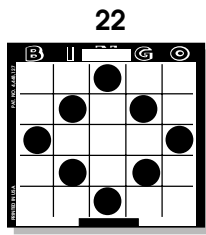

Large Diamond

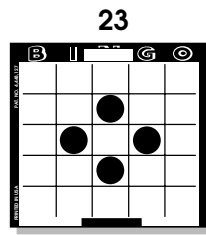

Small Diamond

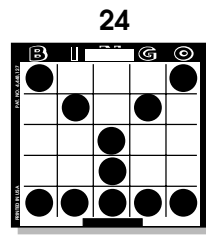

Empty Glass

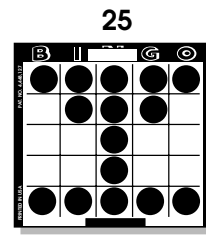

Full Glass



Color Statesman Pre-Programmed Game Patterns 26-50

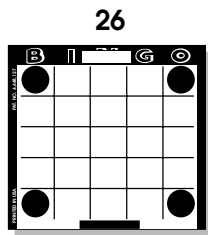

Outside  
Four  
Corners

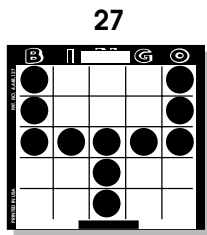

Goal  
Post

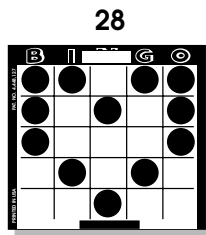

Heart

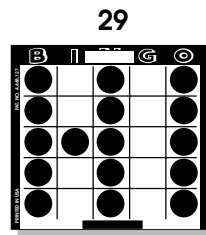

Hi

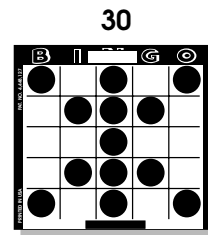

Indian  
Star

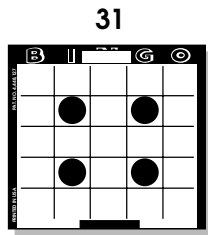

Inside  
Four  
Corners

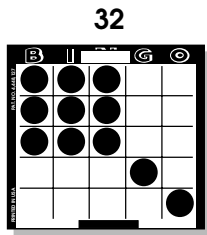

Large  
Kite

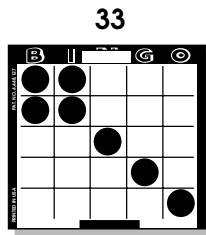

Small  
Kite

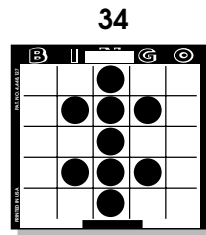

Double  
Cross

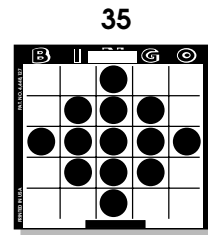

Full  
Diamond

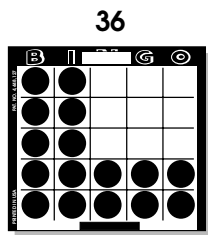

Corner  
Stone

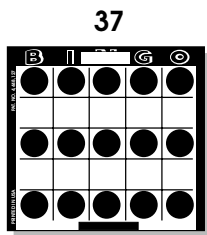

Layer  
Cake

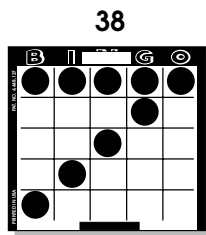

Lucky 7

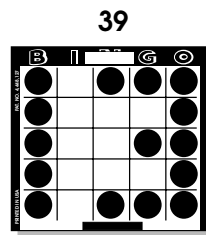

Lucky  
13

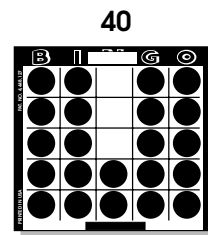

Moat

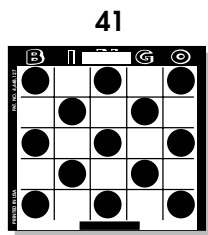

Plaid

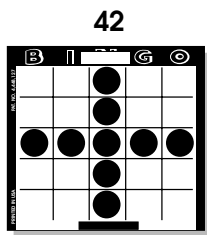

Plus

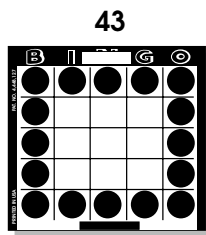

Outside  
Picture Frame

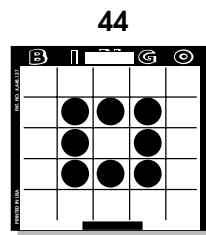

Inside  
Picture Frame

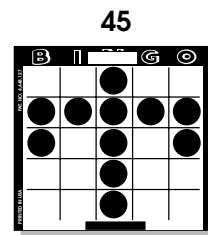

Thunder  
Bird

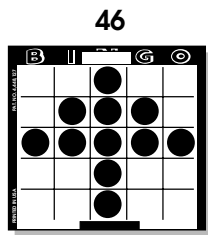

Xmas  
Tree

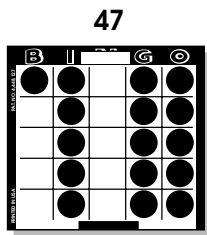

7-11

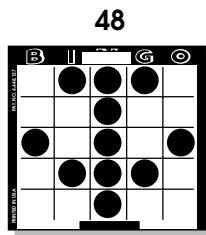

Anchor

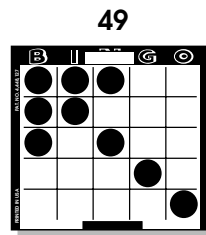

Arrow 1

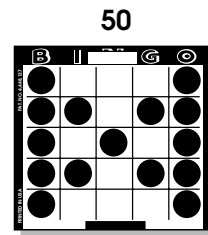

Butterfly

Color Statesman Pre-Programmed Game Patterns 51-75

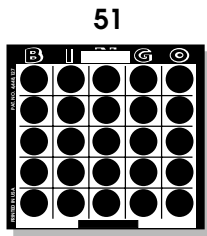

Coverall

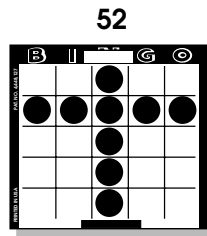

Cross

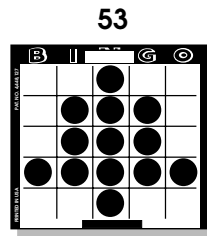

Bell

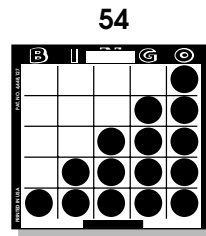

Stairs

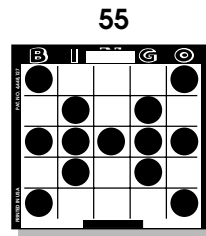

Starburst

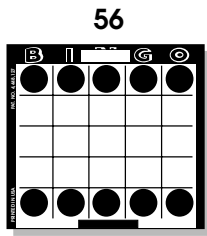

Top and Bottom Rows

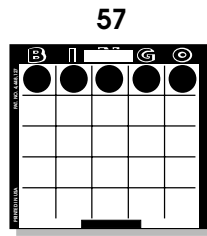

Top or Bottom Row  
(2 Combinations)

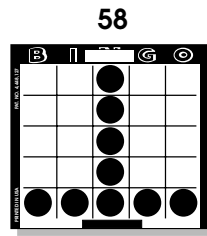

Top or Bottom T  
(2 Combinations)

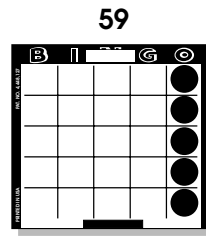

Any Outside Line  
(4 Combinations)

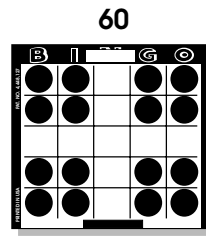

Clover Leaf

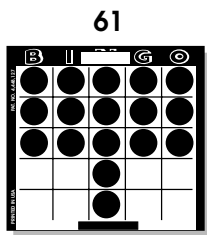

Window Shade

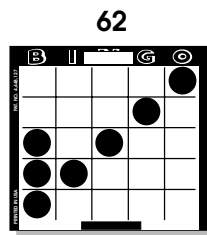

Check Mark

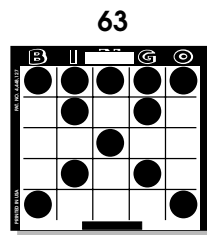

Picnic Table

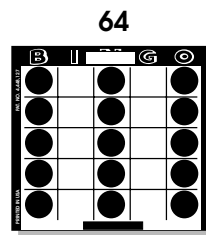

B-N-O Columns

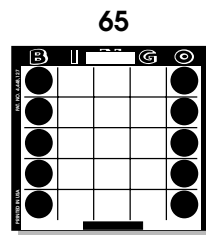

B and O Railroad

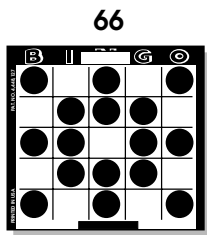

Exploding Star

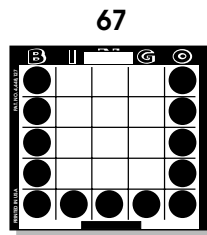

Letter U

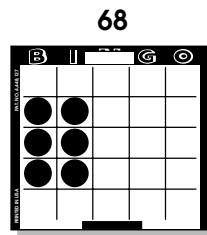

Block of 6  
(22 Combinations)

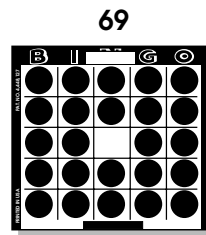

Coverall w/o Free Space

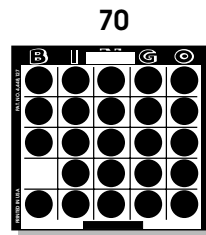

Open House  
(23 Combinations)

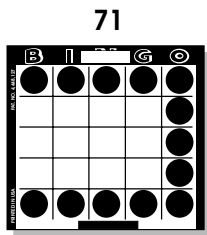

Crazy C  
(4 Combinations)

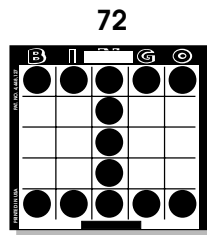

Crazy H  
(2 Combinations)

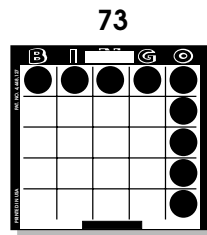

Crazy L  
(4 Combinations)

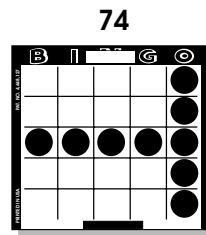

Crazy T  
(4 Combinations)

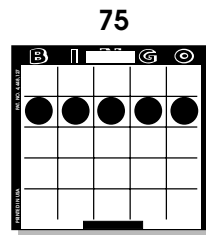

Any Horizontal Line  
(5 Combinations)

Color Statesman Pre-Programmed Game Patterns 76-100

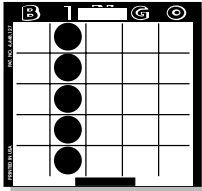
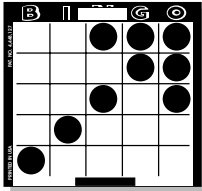
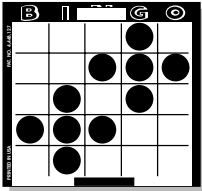
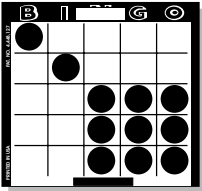
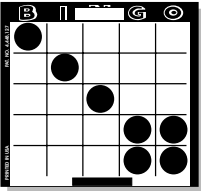
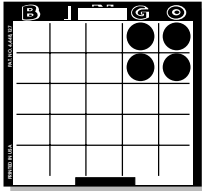
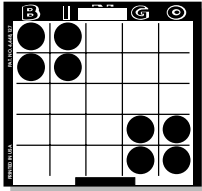
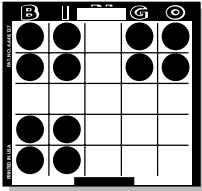
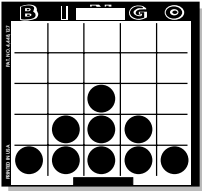
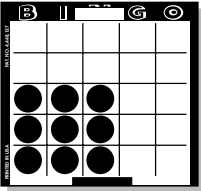
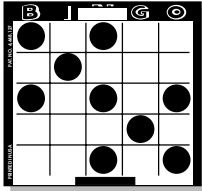
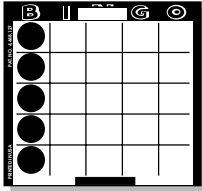
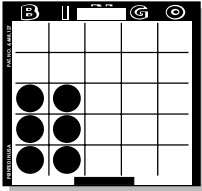
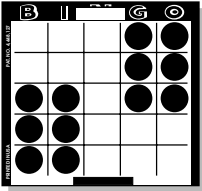
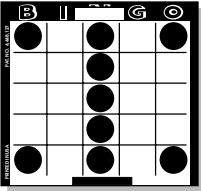
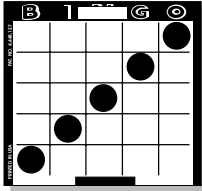
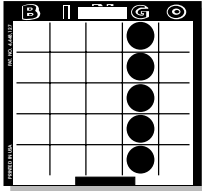
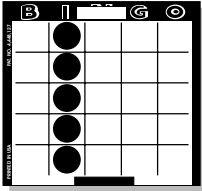
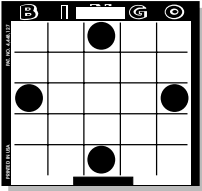
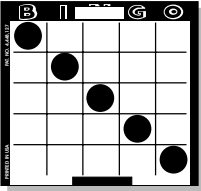
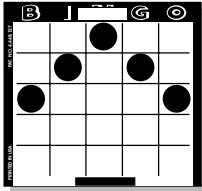
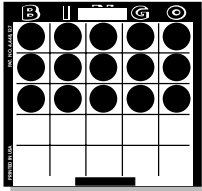
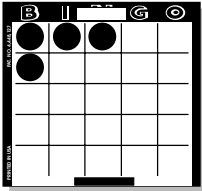
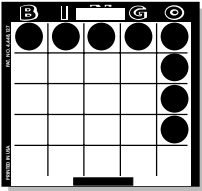
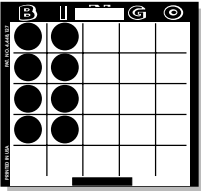
76  Any Vertical Line (5 Combinations)	77  Crazy Arrow (4 Combinations)	78  Double Plus (2 Combinations)	79  Crazy Large Kite (4 Combinations)	80  Crazy Small Kite (4 Combinations)
81  Postage Stamp (4 Combinations)	82  Double Stamp (6 Combinations)	83  Triple Stamp (4 Combinations)	84  Crazy Pyramid (4 Combinations)	85  Block of Nine (9 Combinations)
86  Double X (2 Combinations)	87  Regular Bingo w/4 Corners (13 Combinations)	88  Six Pack (Hard Way) (12 Combinations)	89  Double Six Pack (Hard Way) (18 Combinations)	90  Single Line Plus 4 Corners (12 Combinations)
91  Standard Bingo w/o 4 Corners (12 Combinations)	92  Single Line (Hard Way) (8 Combinations)	93  Stand. w/4-Corners Postage Stamp (17 Combinations)	94  Stand. I+O 4C, PS, Small Diamond, Tips Lg. Diamond (20 Combinations)	95  Any Diagonal (2 Combinations)
96  Chevron	97  Stack of 3 (1/2 Coverall) (2 Combinations)	98  4 Around the Corner (13 Combinations)	99  Eight Around the Corner (10 Combinations)	100  Block of 8 (16 Combinations)

J. Operator's Game Pattern Worksheets 101-125

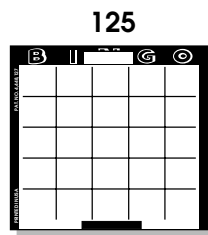
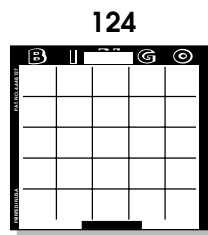
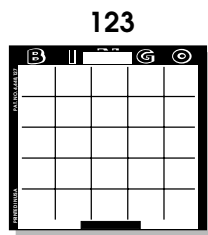
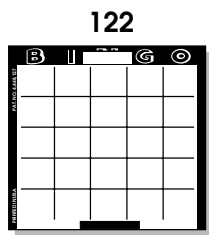
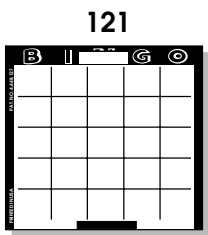
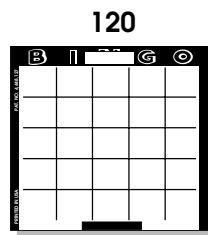
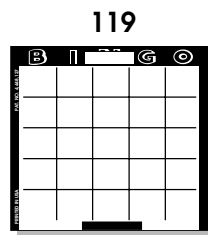
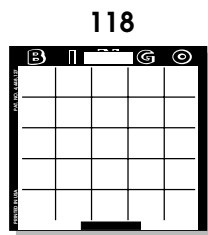
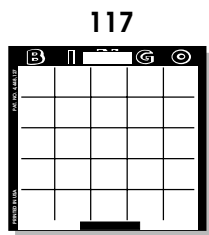
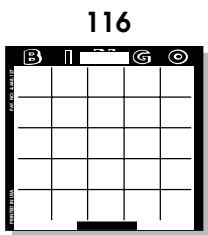
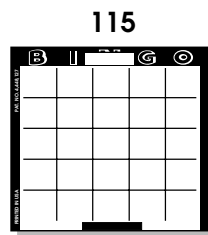
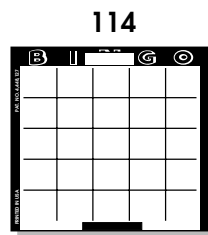
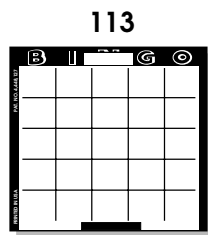
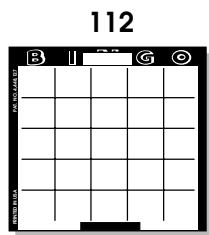
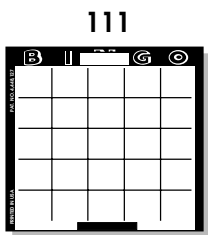
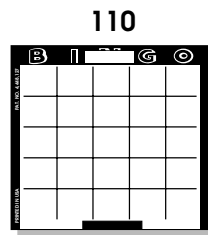
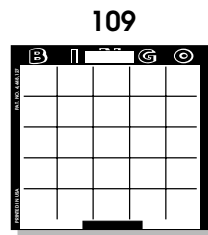
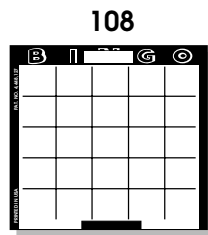
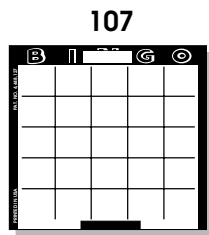
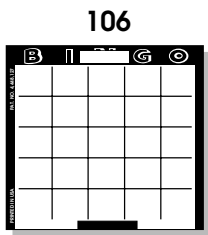
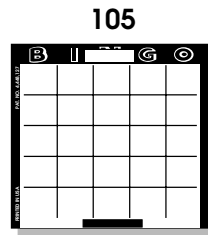
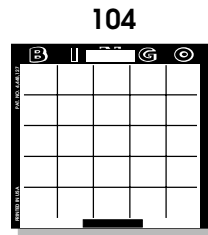
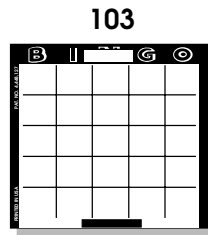
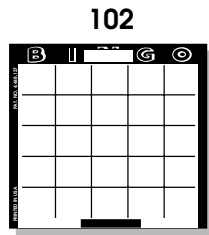
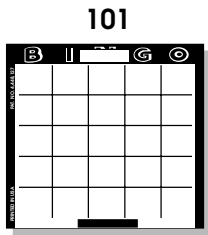

---

Operator's Game Pattern Worksheets 126-150

126

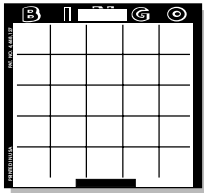

127

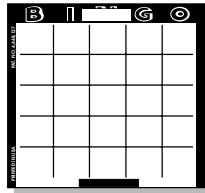

128

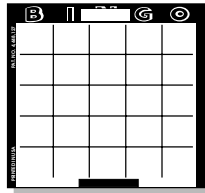

129

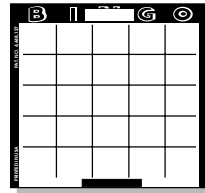

130

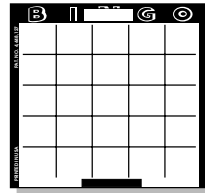

---

131

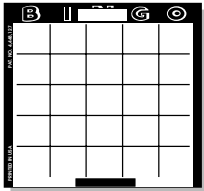

132

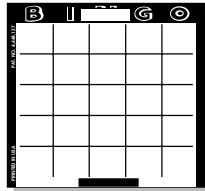

133

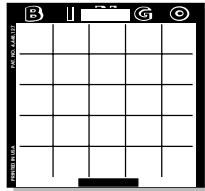

134

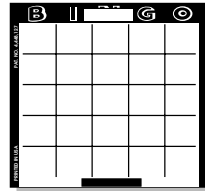

135

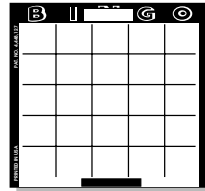

---

136

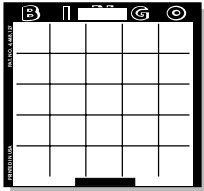

137

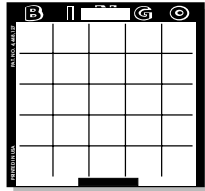

138

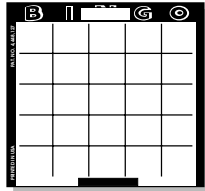

139

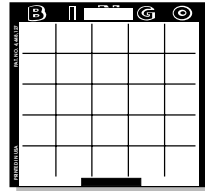

140

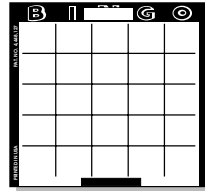

---

141

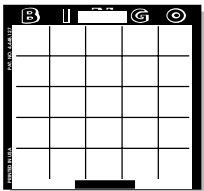

142

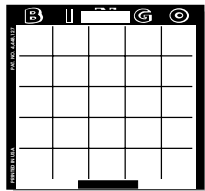

143

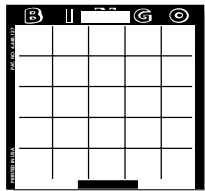

144

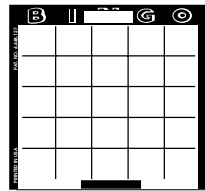

145

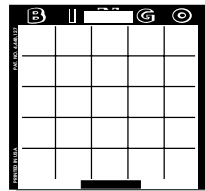

---

146

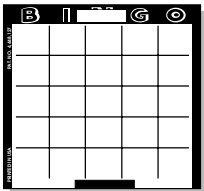

147

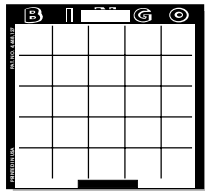

148

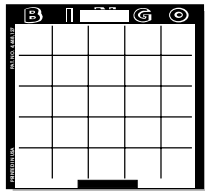

149

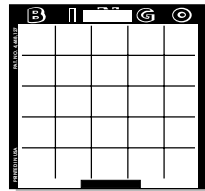

150

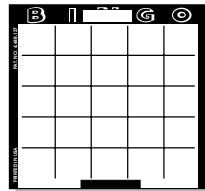

---

Operator's Game Pattern Worksheets 151-175

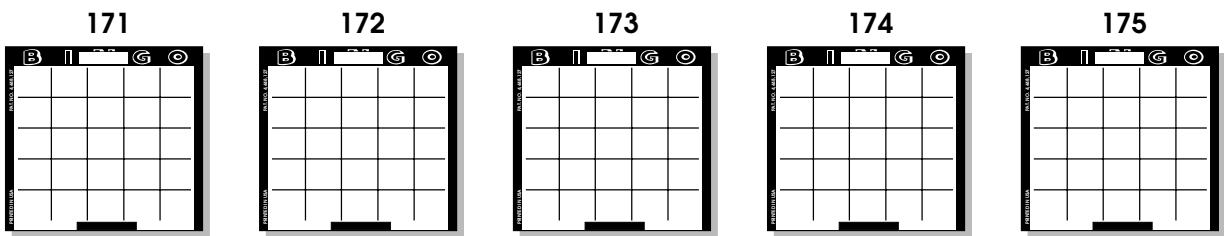
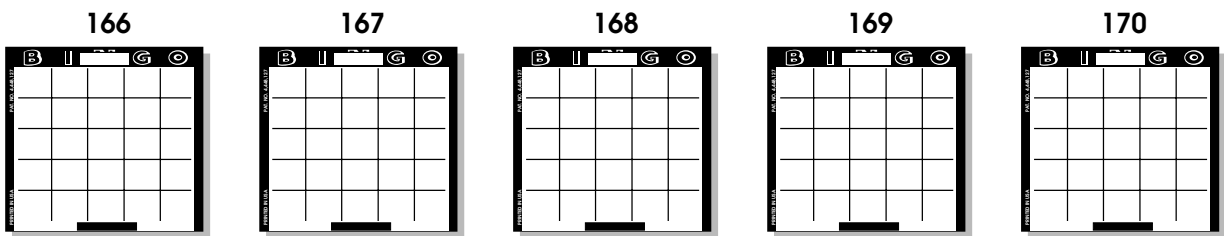
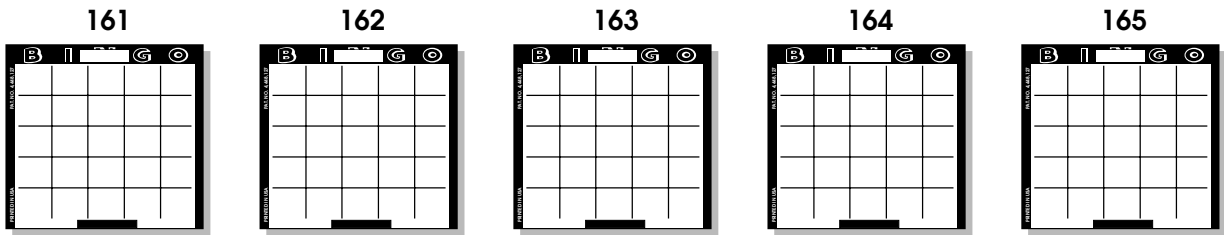
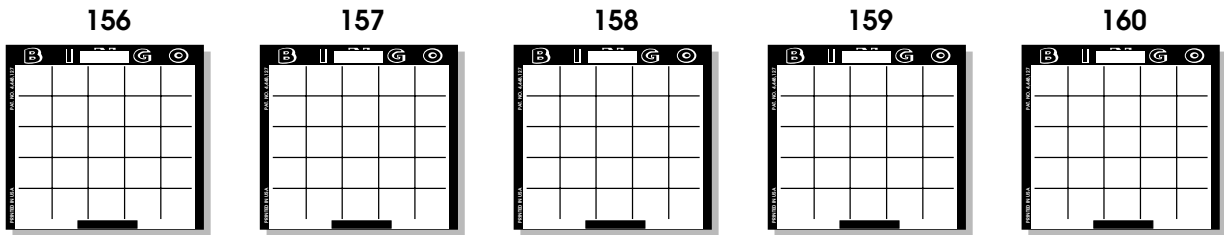
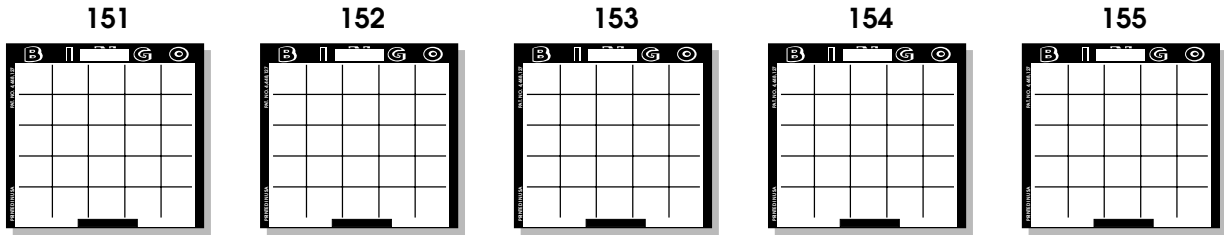

---

Operator's Game Pattern Worksheets 176-200

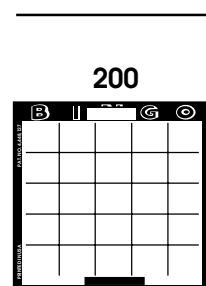
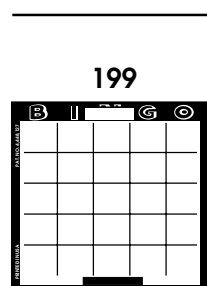
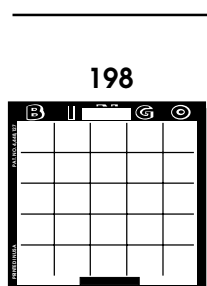
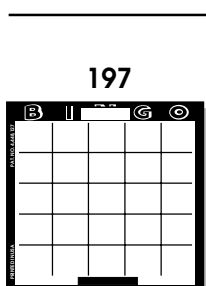
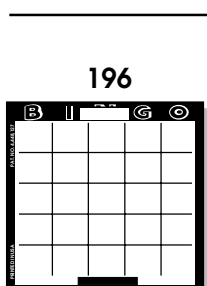
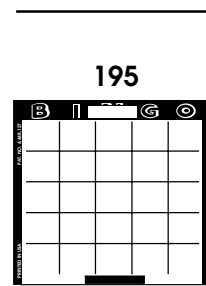
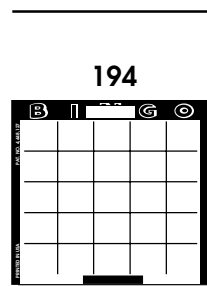
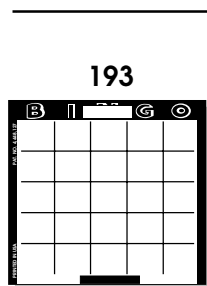
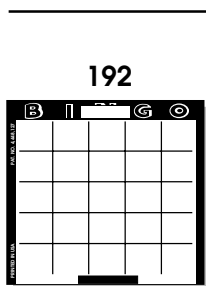
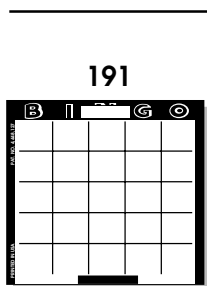
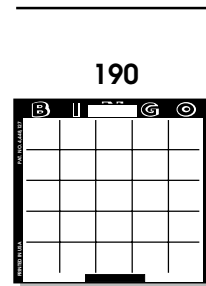
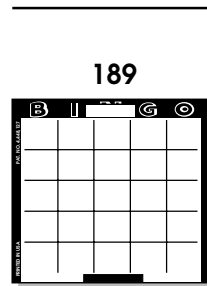
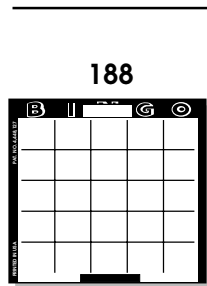
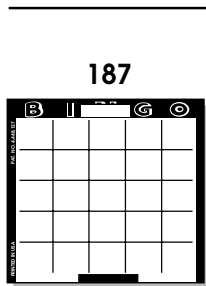
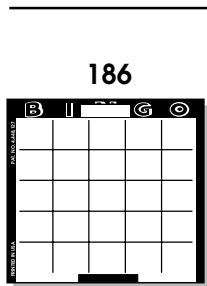
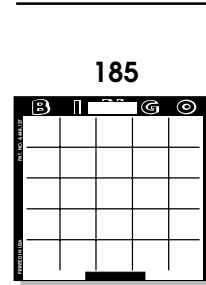
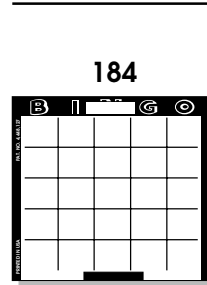
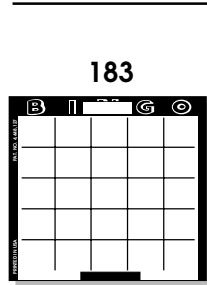
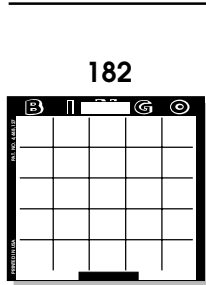
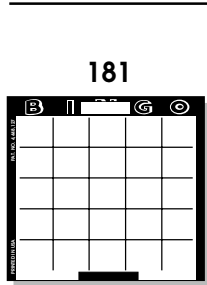
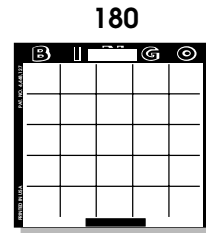
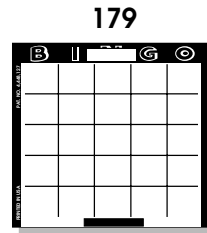
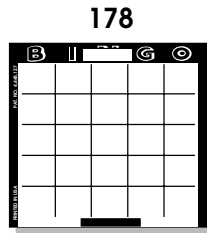
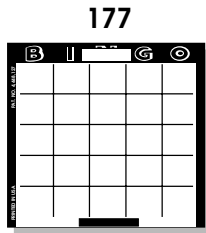
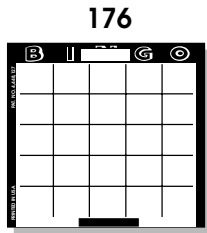

---

Operator's Game Pattern Worksheets 201-225

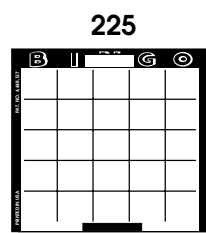
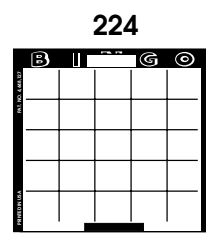
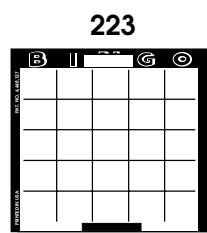
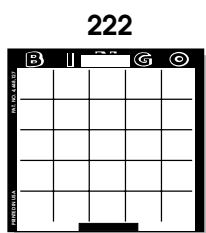
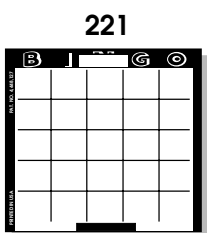
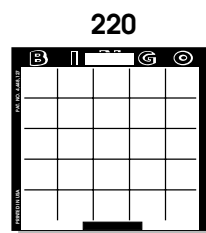
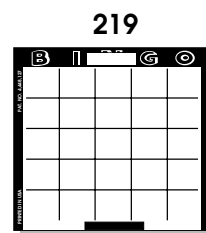
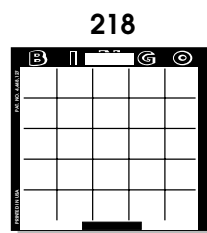
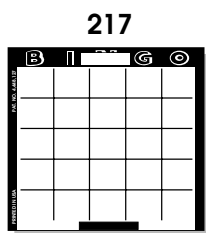
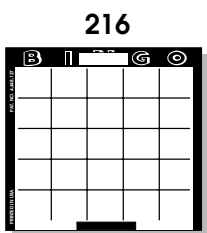
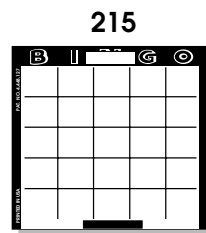
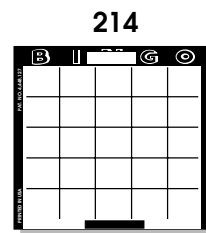
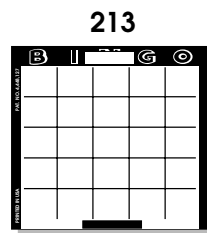
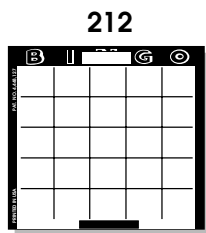
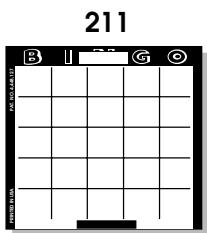
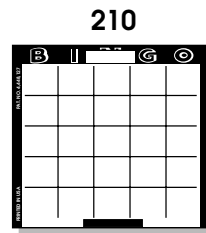
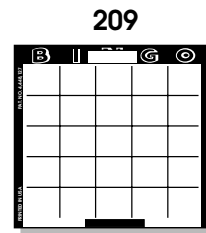
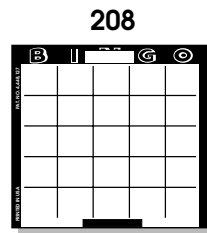
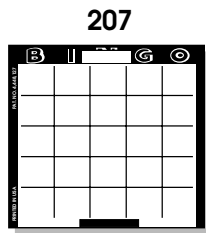
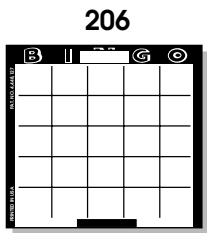
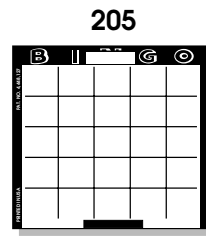
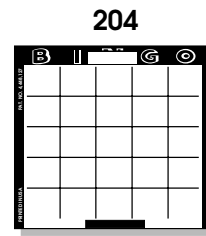
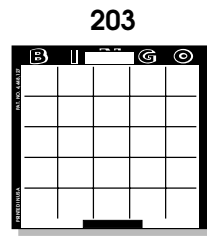
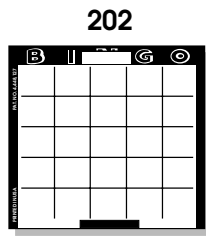
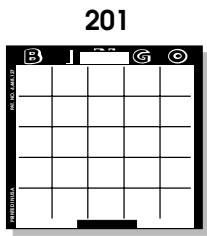



---

Operator's Game Pattern Worksheets 226-240

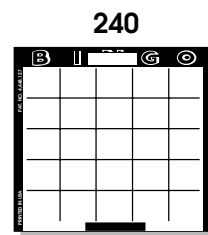
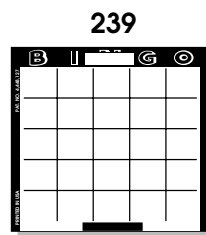
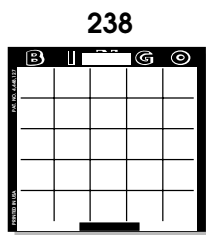
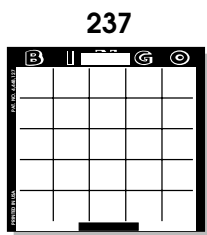
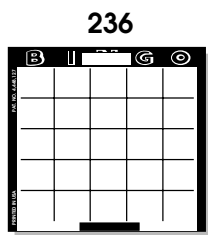
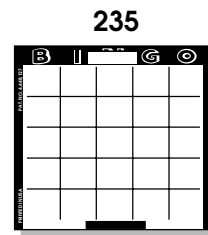
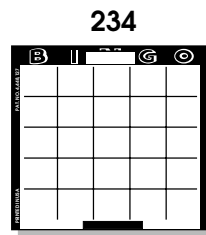
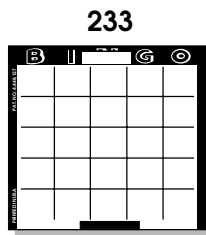
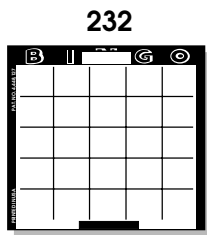
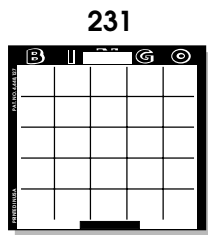
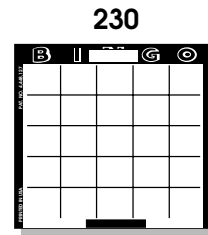
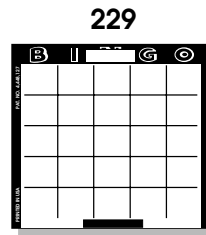
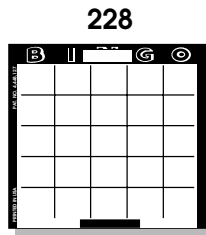
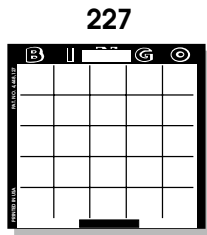
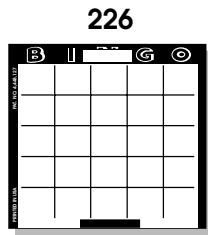

---

K. Session Programming Worksheets 1-10

<b>GAME #1</b>	_____	<b>PATTERN</b>	_____	<b>\$ VALUE</b>	_____	<b>BALL TIMER</b>	_____
	_____		_____		_____		_____
	_____		_____		_____		_____
	_____		_____		_____		_____
<b>GAME #2</b>	_____	<b>PATTERN</b>	_____	<b>\$ VALUE</b>	_____	<b>BALL TIMER</b>	_____
	_____		_____		_____		_____
	_____		_____		_____		_____
	_____		_____		_____		_____
<b>GAME #3</b>	_____	<b>PATTERN</b>	_____	<b>\$ VALUE</b>	_____	<b>BALL TIMER</b>	_____
	_____		_____		_____		_____
	_____		_____		_____		_____
	_____		_____		_____		_____
<b>GAME #4</b>	_____	<b>PATTERN</b>	_____	<b>\$ VALUE</b>	_____	<b>BALL TIMER</b>	_____
	_____		_____		_____		_____
	_____		_____		_____		_____
	_____		_____		_____		_____
<b>GAME #5</b>	_____	<b>PATTERN</b>	_____	<b>\$ VALUE</b>	_____	<b>BALL TIMER</b>	_____
	_____		_____		_____		_____
	_____		_____		_____		_____
	_____		_____		_____		_____
<b>GAME #6</b>	_____	<b>PATTERN</b>	_____	<b>\$ VALUE</b>	_____	<b>BALL TIMER</b>	_____
	_____		_____		_____		_____
	_____		_____		_____		_____
	_____		_____		_____		_____
<b>GAME #7</b>	_____	<b>PATTERN</b>	_____	<b>\$ VALUE</b>	_____	<b>BALL TIMER</b>	_____
	_____		_____		_____		_____
	_____		_____		_____		_____
	_____		_____		_____		_____
<b>GAME #8</b>	_____	<b>PATTERN</b>	_____	<b>\$ VALUE</b>	_____	<b>BALL TIMER</b>	_____
	_____		_____		_____		_____
	_____		_____		_____		_____
	_____		_____		_____		_____
<b>GAME #9</b>	_____	<b>PATTERN</b>	_____	<b>\$ VALUE</b>	_____	<b>BALL TIMER</b>	_____
	_____		_____		_____		_____
	_____		_____		_____		_____
	_____		_____		_____		_____
<b>GAME #10</b>	_____	<b>PATTERN</b>	_____	<b>\$ VALUE</b>	_____	<b>BALL TIMER</b>	_____
	_____		_____		_____		_____
	_____		_____		_____		_____
	_____		_____		_____		_____

---

Session Programming Worksheets 11-20

**GAME #11** \_\_\_\_\_ **PATTERN** \_\_\_\_\_ **\$ VALUE** \_\_\_\_\_ **BALL TIMER** \_\_\_\_\_  
\_\_\_\_\_  
\_\_\_\_\_  
\_\_\_\_\_

**GAME #12** \_\_\_\_\_ **PATTERN** \_\_\_\_\_ **\$ VALUE** \_\_\_\_\_ **BALL TIMER** \_\_\_\_\_  
\_\_\_\_\_  
\_\_\_\_\_  
\_\_\_\_\_

**GAME #13** \_\_\_\_\_ **PATTERN** \_\_\_\_\_ **\$ VALUE** \_\_\_\_\_ **BALL TIMER** \_\_\_\_\_  
\_\_\_\_\_  
\_\_\_\_\_  
\_\_\_\_\_

**GAME #14** \_\_\_\_\_ **PATTERN** \_\_\_\_\_ **\$ VALUE** \_\_\_\_\_ **BALL TIMER** \_\_\_\_\_  
\_\_\_\_\_  
\_\_\_\_\_  
\_\_\_\_\_

**GAME #15** \_\_\_\_\_ **PATTERN** \_\_\_\_\_ **\$ VALUE** \_\_\_\_\_ **BALL TIMER** \_\_\_\_\_  
\_\_\_\_\_  
\_\_\_\_\_  
\_\_\_\_\_

**GAME #16** \_\_\_\_\_ **PATTERN** \_\_\_\_\_ **\$ VALUE** \_\_\_\_\_ **BALL TIMER** \_\_\_\_\_  
\_\_\_\_\_  
\_\_\_\_\_  
\_\_\_\_\_

**GAME #17** \_\_\_\_\_ **PATTERN** \_\_\_\_\_ **\$ VALUE** \_\_\_\_\_ **BALL TIMER** \_\_\_\_\_  
\_\_\_\_\_  
\_\_\_\_\_  
\_\_\_\_\_

**GAME #18** \_\_\_\_\_ **PATTERN** \_\_\_\_\_ **\$ VALUE** \_\_\_\_\_ **BALL TIMER** \_\_\_\_\_  
\_\_\_\_\_  
\_\_\_\_\_  
\_\_\_\_\_

**GAME #19** \_\_\_\_\_ **PATTERN** \_\_\_\_\_ **\$ VALUE** \_\_\_\_\_ **BALL TIMER** \_\_\_\_\_  
\_\_\_\_\_  
\_\_\_\_\_  
\_\_\_\_\_

**GAME #20** \_\_\_\_\_ **PATTERN** \_\_\_\_\_ **\$ VALUE** \_\_\_\_\_ **BALL TIMER** \_\_\_\_\_  
\_\_\_\_\_  
\_\_\_\_\_  
\_\_\_\_\_

---

Session Programming Worksheets 21-30

**GAME #21** \_\_\_\_\_ **PATTERN** \_\_\_\_\_ **\$ VALUE** \_\_\_\_\_ **BALL TIMER** \_\_\_\_\_  
\_\_\_\_\_  
\_\_\_\_\_  
\_\_\_\_\_

**GAME #22** \_\_\_\_\_ **PATTERN** \_\_\_\_\_ **\$ VALUE** \_\_\_\_\_ **BALL TIMER** \_\_\_\_\_  
\_\_\_\_\_  
\_\_\_\_\_  
\_\_\_\_\_

**GAME #23** \_\_\_\_\_ **PATTERN** \_\_\_\_\_ **\$ VALUE** \_\_\_\_\_ **BALL TIMER** \_\_\_\_\_  
\_\_\_\_\_  
\_\_\_\_\_  
\_\_\_\_\_

**GAME #24** \_\_\_\_\_ **PATTERN** \_\_\_\_\_ **\$ VALUE** \_\_\_\_\_ **BALL TIMER** \_\_\_\_\_  
\_\_\_\_\_  
\_\_\_\_\_  
\_\_\_\_\_

**GAME #25** \_\_\_\_\_ **PATTERN** \_\_\_\_\_ **\$ VALUE** \_\_\_\_\_ **BALL TIMER** \_\_\_\_\_  
\_\_\_\_\_  
\_\_\_\_\_  
\_\_\_\_\_

**GAME #26** \_\_\_\_\_ **PATTERN** \_\_\_\_\_ **\$ VALUE** \_\_\_\_\_ **BALL TIMER** \_\_\_\_\_  
\_\_\_\_\_  
\_\_\_\_\_  
\_\_\_\_\_

**GAME #27** \_\_\_\_\_ **PATTERN** \_\_\_\_\_ **\$ VALUE** \_\_\_\_\_ **BALL TIMER** \_\_\_\_\_  
\_\_\_\_\_  
\_\_\_\_\_  
\_\_\_\_\_

**GAME #28** \_\_\_\_\_ **PATTERN** \_\_\_\_\_ **\$ VALUE** \_\_\_\_\_ **BALL TIMER** \_\_\_\_\_  
\_\_\_\_\_  
\_\_\_\_\_  
\_\_\_\_\_

**GAME #29** \_\_\_\_\_ **PATTERN** \_\_\_\_\_ **\$ VALUE** \_\_\_\_\_ **BALL TIMER** \_\_\_\_\_  
\_\_\_\_\_  
\_\_\_\_\_  
\_\_\_\_\_

**GAME #30** \_\_\_\_\_ **PATTERN** \_\_\_\_\_ **\$ VALUE** \_\_\_\_\_ **BALL TIMER** \_\_\_\_\_  
\_\_\_\_\_  
\_\_\_\_\_  
\_\_\_\_\_

---

Session Programming Worksheets 31-40

**GAME #31** \_\_\_\_\_ **PATTERN** \_\_\_\_\_ **\$ VALUE** \_\_\_\_\_ **BALL TIMER** \_\_\_\_\_  
\_\_\_\_\_  
\_\_\_\_\_  
\_\_\_\_\_

**GAME #32** \_\_\_\_\_ **PATTERN** \_\_\_\_\_ **\$ VALUE** \_\_\_\_\_ **BALL TIMER** \_\_\_\_\_  
\_\_\_\_\_  
\_\_\_\_\_  
\_\_\_\_\_

**GAME #33** \_\_\_\_\_ **PATTERN** \_\_\_\_\_ **\$ VALUE** \_\_\_\_\_ **BALL TIMER** \_\_\_\_\_  
\_\_\_\_\_  
\_\_\_\_\_  
\_\_\_\_\_

**GAME #34** \_\_\_\_\_ **PATTERN** \_\_\_\_\_ **\$ VALUE** \_\_\_\_\_ **BALL TIMER** \_\_\_\_\_  
\_\_\_\_\_  
\_\_\_\_\_  
\_\_\_\_\_

**GAME #35** \_\_\_\_\_ **PATTERN** \_\_\_\_\_ **\$ VALUE** \_\_\_\_\_ **BALL TIMER** \_\_\_\_\_  
\_\_\_\_\_  
\_\_\_\_\_  
\_\_\_\_\_

**GAME #36** \_\_\_\_\_ **PATTERN** \_\_\_\_\_ **\$ VALUE** \_\_\_\_\_ **BALL TIMER** \_\_\_\_\_  
\_\_\_\_\_  
\_\_\_\_\_  
\_\_\_\_\_

**GAME #37** \_\_\_\_\_ **PATTERN** \_\_\_\_\_ **\$ VALUE** \_\_\_\_\_ **BALL TIMER** \_\_\_\_\_  
\_\_\_\_\_  
\_\_\_\_\_  
\_\_\_\_\_

**GAME #38** \_\_\_\_\_ **PATTERN** \_\_\_\_\_ **\$ VALUE** \_\_\_\_\_ **BALL TIMER** \_\_\_\_\_  
\_\_\_\_\_  
\_\_\_\_\_  
\_\_\_\_\_

**GAME #39** \_\_\_\_\_ **PATTERN** \_\_\_\_\_ **\$ VALUE** \_\_\_\_\_ **BALL TIMER** \_\_\_\_\_  
\_\_\_\_\_  
\_\_\_\_\_  
\_\_\_\_\_

**GAME #40** \_\_\_\_\_ **PATTERN** \_\_\_\_\_ **\$ VALUE** \_\_\_\_\_ **BALL TIMER** \_\_\_\_\_  
\_\_\_\_\_  
\_\_\_\_\_  
\_\_\_\_\_

---

Session WorkSheets Game 41-50

**GAME #41** \_\_\_\_\_ **PATTERN** \_\_\_\_\_ **\$ VALUE** \_\_\_\_\_ **BALL TIMER** \_\_\_\_\_  
\_\_\_\_\_  
\_\_\_\_\_  
\_\_\_\_\_

**GAME #42** \_\_\_\_\_ **PATTERN** \_\_\_\_\_ **\$ VALUE** \_\_\_\_\_ **BALL TIMER** \_\_\_\_\_  
\_\_\_\_\_  
\_\_\_\_\_  
\_\_\_\_\_

**GAME #43** \_\_\_\_\_ **PATTERN** \_\_\_\_\_ **\$ VALUE** \_\_\_\_\_ **BALL TIMER** \_\_\_\_\_  
\_\_\_\_\_  
\_\_\_\_\_  
\_\_\_\_\_

**GAME #44** \_\_\_\_\_ **PATTERN** \_\_\_\_\_ **\$ VALUE** \_\_\_\_\_ **BALL TIMER** \_\_\_\_\_  
\_\_\_\_\_  
\_\_\_\_\_  
\_\_\_\_\_

**GAME #45** \_\_\_\_\_ **PATTERN** \_\_\_\_\_ **\$ VALUE** \_\_\_\_\_ **BALL TIMER** \_\_\_\_\_  
\_\_\_\_\_  
\_\_\_\_\_  
\_\_\_\_\_

**GAME #46** \_\_\_\_\_ **PATTERN** \_\_\_\_\_ **\$ VALUE** \_\_\_\_\_ **BALL TIMER** \_\_\_\_\_  
\_\_\_\_\_  
\_\_\_\_\_  
\_\_\_\_\_

**GAME #47** \_\_\_\_\_ **PATTERN** \_\_\_\_\_ **\$ VALUE** \_\_\_\_\_ **BALL TIMER** \_\_\_\_\_  
\_\_\_\_\_  
\_\_\_\_\_  
\_\_\_\_\_

**GAME #48** \_\_\_\_\_ **PATTERN** \_\_\_\_\_ **\$ VALUE** \_\_\_\_\_ **BALL TIMER** \_\_\_\_\_  
\_\_\_\_\_  
\_\_\_\_\_  
\_\_\_\_\_

**GAME #49** \_\_\_\_\_ **PATTERN** \_\_\_\_\_ **\$ VALUE** \_\_\_\_\_ **BALL TIMER** \_\_\_\_\_  
\_\_\_\_\_  
\_\_\_\_\_  
\_\_\_\_\_

**GAME #50** \_\_\_\_\_ **PATTERN** \_\_\_\_\_ **\$ VALUE** \_\_\_\_\_ **BALL TIMER** \_\_\_\_\_  
\_\_\_\_\_  
\_\_\_\_\_  
\_\_\_\_\_

---

## IV. Running Individual Games and Sessions

---

### A. Playing the Bingo Game

To begin a bingo session, turn on the main console power switch, the blower lamp switch, mixer motor switch and then the blower motor switch on the Color Statesman console. You will notice that balls are immediately blown up the ball tube and held in the ball catcher available for play.

Next, turn on the power switch to all flashboards on the system. The flashboards will go through a self test on initial power up. By pressing the "SPECIAL" and "TEST" keys on the Color Statesman console, all the lights will illuminate to check for any light bulbs out before the play of bingo.

The timer will evenly pace your ball calling, adjust the pace of the game and build player confidence to play additional bingo faces with the same payout, thus increasing your revenues. Until you find a time that is most comfortable for you and your players, a good calling time might be every 14 to 20 seconds. When the beeper sounds, it is time to call the next ball.

When you are ready to begin, place the first ball in front of the camera for a few seconds. Call that number and place the ball in the corresponding slot in the ball tray. Remove the next ball from the ball catcher and place it in front of the camera. The caller should never be handling more than one ball at any time. When the timer sounds, call the number of the ball in front of the camera and place it in the corresponding slot in the ball tray. Continue this procedure until bingo is called.

At this time verify all the bingo's that have been called. It is usually best if the floor worker calls out the serial number of the bingo paper to verify purchase from your hall. Then have the floor worker call out the free space number one digit at a time with the caller entering the number simultaneously.

At the end of the game, press the "NEXT GAME" key. Drop the balls from the tray by pushing both ball release tabs forward fully. The ball gate release knob must be turned counterclockwise to dump the balls back into the ball mixing chamber. This gate acts as a security barrier in order to prevent the balls from reentering the ball mixing chamber. Air in the mixing chamber can occasionally prevent the balls from dumping normally. If this happens, briefly turn off the blower motor switch, allow the balls to drop, and turn the blower motor switch back on.

Be sure to visually check the ball return tray and chute to verify that all balls have been returned to the ball mixing chamber. Do not forget the ball in front of the camera. Press the "ENTER" key and you are ready for the next game.

At the end of the session simply turn off all power switches.

*Note: When placing balls in the ball tray, be sure to press the ball down until you hear the console beep.*

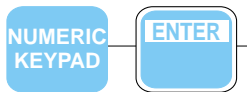
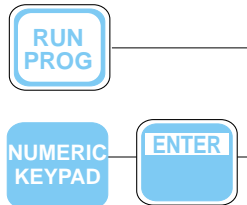
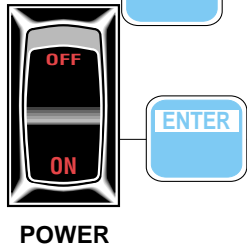
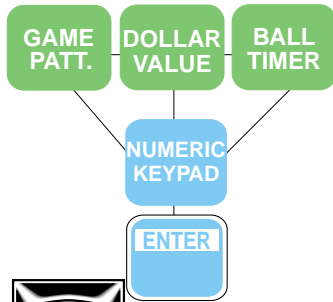
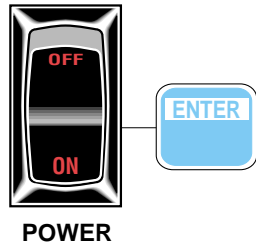

*Note: If beginning a session, press "1" for the first game in the session.*

### B. Manual Game

1. Turn the "POWER" switch on.
2. Press the "ENTER" key.

The display will read:

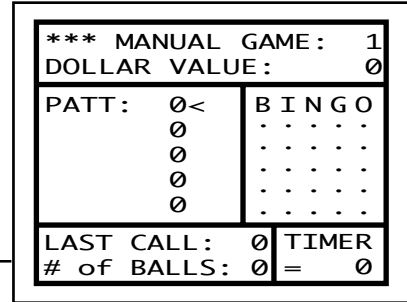

You may now enter the data for the game patterns, dollar value and ball timer via the numeric keypad.

3. To enter any data, press the "GAME PATT.," "DOLLAR VALUE," or "BALL TIMER" key and select the desired value or pattern using the numeric keypad.
4. Complete each selection with the "ENTER" key.

### C. Pre-Programmed Session

1. Turn the "POWER" switch on.
2. Press the "ENTER" key.
3. Press the "RUN PROG." key.

The display will read:

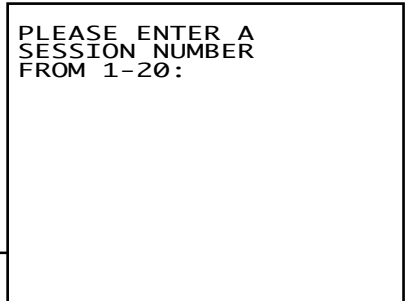

4. Enter the session number using the numeric keypad.
5. Press the "ENTER" key.

The display will read:

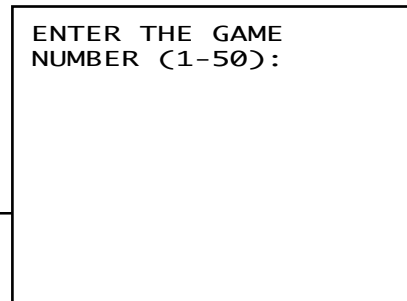

6. Enter the game number using the numeric keypad. **Refer to note.**
7. Press the "ENTER" key.

The display will read:

(The numbers shown here are examples.)

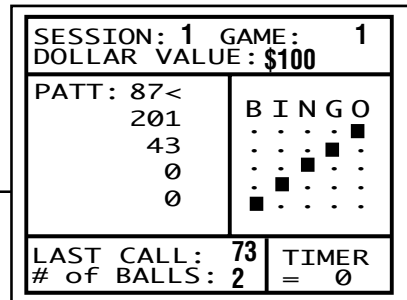



8. Turn on the "MIXER" switch.
9. Turn on the "BLOWER" switch.
10. Begin the play of the game.
11. Upon completion and verification of the first game pattern, use the "NEXT PATT." key to move the cursor to the next game pattern if this is a progressive game.

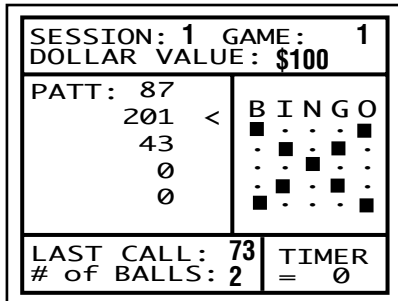

The display will read:

The game pattern number display will show the cursor next to the game pattern number currently in play and the screen will display the game pattern selected.

12. When you are ready to move to the next game in your session, press the "NEXT GAME" key, followed by the "ENTER" key. (Refer to the illustration below for the proper procedure to return balls to the ball mixing chamber.) You may press the "CANCEL" key to resume your current game if the "NEXT GAME" key was pressed in error.

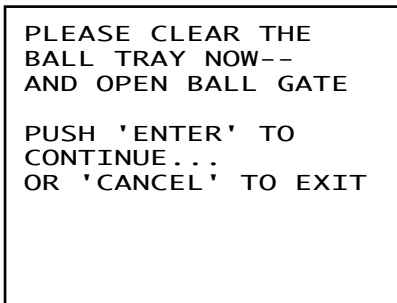

The display will read:

13. Begin the next game.

To exit the session, press the "SPECIAL" key followed by the "EXIT" key.

The display will read:

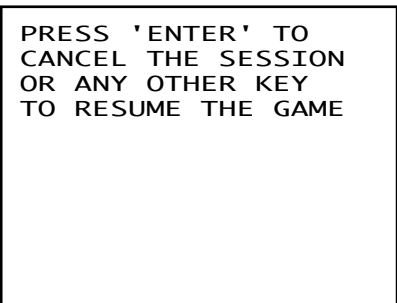

14. Press the "ENTER" key to return to manual game mode.

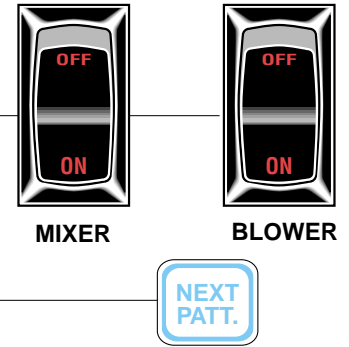

*Note: The numeric display on the flashboard will show the "game number" between games and will automatically switch to the "total number of balls called" with the calling of the first ball if the "total number of balls called" was selected in setup.*

*Note: If "NEXT PATT." is pressed too many times, continue pressing the "NEXT PATT." key until the cursor corresponds with the desired game pattern.*

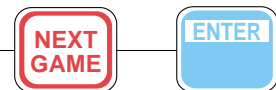

*Note: If "NEXT GAME" is pressed in error, press "CANCEL" to return to previous game.*

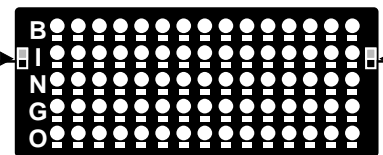

*Note: To clear the ball tray, turn the blower motor switch off, push the ball tray release tabs fully forward and open the gate to return the balls to the ball mixing chamber.*



Note: Changing of pre-programmed data is a temporary change of data and will display pre-programmed data the next time the pre-programmed session is called up.

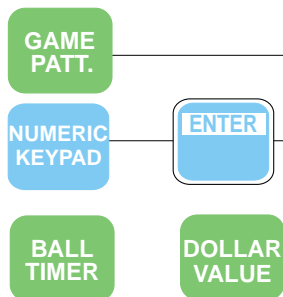

#### D. Changing Pre-Programmed Game Data

The pre-programmed data may be temporarily changed at any time.

1. To enter a new game pattern, press the "GAME PATT." key.
2. Enter the new game pattern number using the numeric keypad.
3. Press the "ENTER" key. The screen will display the new game pattern.

The same may be done for the ball timer and dollar value amounts.

4. Begin or resume play of the game.

#### E. Canceling a Ball

If a ball has been inserted in the wrong numbered slot:

1. Remove the ball from the incorrect ball tray slot.
2. Press the "CANCEL" key.

The display will read:

Ball to Cancel:

3. Type in the number of the ball to cancel using the numeric keypad.
4. Press the "ENTER" key.

The display will read:

The incorrect number will disappear from the flash-board and the total number of balls called display will decrease by one.

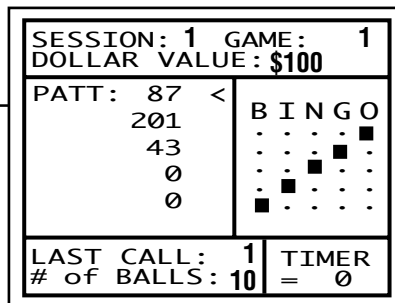

The timer will begin to countdown.

5. Insert the ball into the correct ball tray slot.
6. Resume play of the game.

**F. Verifying a Bingo**  
**1. Verifying Standard Capitol**  
**Bingo Series**

VERIFY OPTIONS:  
 SPEC. = SELECT PAPER  
 W = WIN TALLY  
 S = ERASE WIN PATTS.  
 CANCEL = RETURN

ENTER STANDARD  
 FACE NUMBER:

When a player or players call "BINGO."

a. Press the "VERIFY" key.



The display will read:

The Statesman Color system will automatically verify a "BINGO" from standard Capitol Bingo series unless you choose "SPECIAL" for another Capitol series.

*Note: The Statesman Color System will automatically verify a BINGO from the standard Capitol series unless you press "SPECIAL" for other Capitol Bingo paper series.*

VERIFY OPTIONS:  
 SPEC. = SELECT PAPER  
 W = WIN TALLY  
 S = ERASE WIN PATTS.  
 CANCEL = RETURN

ENTER STANDARD  
 FACE NUMBER: **54000**

b. Enter the freespace number on the numeric keypad from the card of the person who called bingo.



The display will read:

c. Press the "ENTER" key.



The display will read:

(This winning face is used as an example.)

The screen will display the word "winner" if that free space number is indeed a winner.

d. If you have another bingo to verify, press the "ENTER" key.



The display will return to the "Verify Options" screen.

The display will read:

B	I	N	G	O	W I N N E R
11	23	31	51	65	
13	22	32	60	73	
6	30	00	50	61	
2	25	39	48	70	
15	27	33	56	75	

/R/E\ SPACE = **54000**

VERIFY OPTIONS:  
 SPEC. = SELECT PAPER  
 W = WIN TALLY  
 S = ERASE WIN PATTS.  
 CANCEL = RETURN

ENTER STANDARD  
 FACE NUMBER:

*Note: House rules may mandate that a valid bingo must include the last number called in a winning bingo pattern. The Statesman Color System will flash the last number called if it is on that bingo face. Verification on last number called is an option that must be selected in the System Setup.*



You may continue to verify other bingo's by entering additional freespace numbers. (Refer to steps b and c above.)

- e. If you have more than one winner in a game, you may press the "W" key to calculate the payouts to each winner based on the dollar amount previously entered for the game.

The display will read:

CURRENTLY:       **2**  
WINNERS DETECTED-  
IF DIFFERENT, ENTER  
NEW NUMBER OF  
WINNERS:



If your total number of winners does not correspond to the system total, enter the new number of winners

using the numeric keypad before pressing the "ENTER" key.

The display will read:

EACH OF THE       **3**  
WINNERS GETS     **\$33.33**  
  
PRESS ANY KEY TO  
RETURN TO VERIFIER

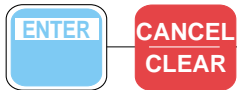

- f. To exit the verify mode, press the "ENTER" key and then press the "CANCEL" key to return to the play mode.

## 2. Verifying other Capitol Bingo Series

If verifying Capitol paper other than the standard bingo series. When a player or players call "Bingo";

### VERIFY OPTIONS:

SPEC. = SELECT PAPER  
W = WIN TALLY  
S = ERASE WIN PATTS.  
CANCEL = RETURN

ENTER STANDARD  
FACE NUMBER:

a. Press the "VERIFY" key.

The display will read:



### ENTER SERIES TYPE:

1. CAPITOL BINGO
2. DAB ALL 75
3. MINI 75
4. DUAL DAB

PRESS ANY OTHER KEY  
TO EXIT:

b. Press the "SPECIAL" key.

The display will read:

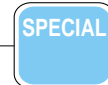

### ENTER SERIES TYPE:

1. CAPITOL BINGO
2. DAB ALL 75
3. MINI 75
4. DUAL DAB

ENTER DAB ALL 75  
FACE NUMBER:

c. Using the numeric keypad  
select the number  
corresponding to the paper  
series you wish to verify.  
(i.e. "2" for Dab All 75)

The display will read:



d. Enter the freespace number  
on the numeric keypad from  
the card of the person who  
called bingo.

*Dual Dab verification displays only  
the called numbers in the pattern,  
not both sets.*

e. Press the "ENTER" key.

The display will read:

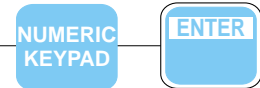

(This winning face is used as  
an example.)

The screen will display the  
word "WINNER" if that free  
space number is indeed a  
winner.



f. If you have additional bingos,  
press the "ENTER" key and  
repeat steps C, D and E.  
If you have no additional  
bingo's press the "CANCEL"  
key twice to return to the  
game mode.



*Note: Unit defaults to Capitol each  
time verify mode is entered.*

B	I	N	G	O	W D
7	17	33	47	70	I A
1	22	45	58	73	N B
6	21	-	49	68	N A
10	18	34	51	71	E L
4	16	32	55	61	R L
FREE SPACE = 18000					

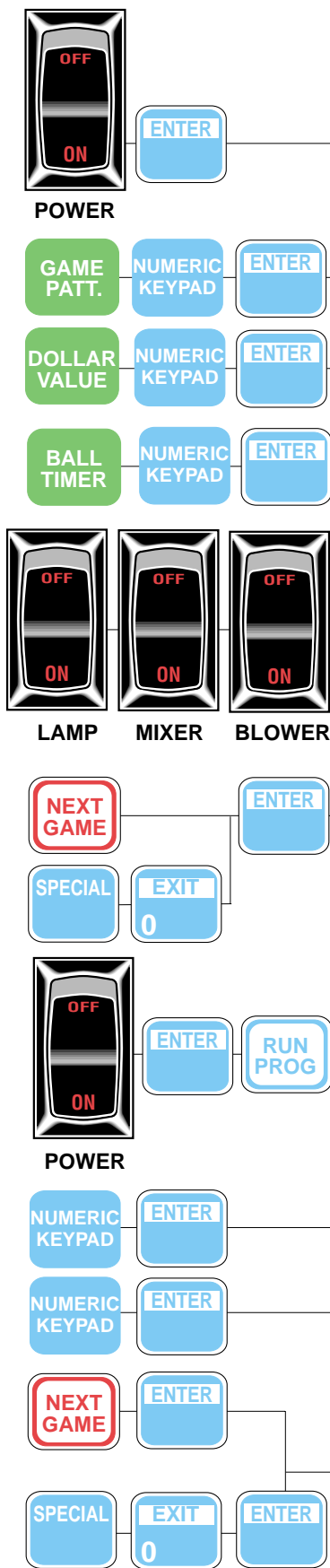

### G. Quick Reference Guide -Running a Manual Game

1. Turn the "POWER" switch on.
2. Press the "ENTER" key.
3. Press the "GAME PATT." key, then enter your game pattern number using the numeric keypad and then press the "ENTER" key.
4. Press the "DOLLAR VALUE" key, enter the dollar amount using the numeric keypad and then press the "ENTER" key.
5. Press the "BALL TIMER" key, enter the interval of time using the numeric keypad and then press the "ENTER" key.
6. Turn on the ball mixing chamber lamp switch, the ball mixer switch, then the ball blower switch.
7. Begin play of the game by calling balls and inserting them into the ball tray.
8. After a valid bingo has been detected, refer to section I, Verifying a Bingo (p. 47), and when the game is over, press either the "NEXT GAME" key followed by the "ENTER" key to proceed to the next game or, if you wish to exit the session, press the "SPECIAL" key, the "EXIT" key and then the "ENTER" key.

### H. Quick Reference Guide -Running a Session

1. Turn the "POWER" switch on.
2. Press the "ENTER" key.
3. Press the "RUN PROG." key.
4. Type in the session number (1-20) using the numeric keypad and press the "ENTER" key.
5. Type in the game number (1-50) using the numeric keypad, then press the "ENTER" key. If beginning a session, press "1" for the first game in the session.
6. Turn on the ball mixing chamber lamp switch, the ball mixer switch, then the blower switch.
7. Begin play of the game by calling balls and inserting them into the ball tray.
8. After a valid bingo has been detected, refer to section I, Verifying a Bingo (p. 47), and when the game is over, press either the "NEXT GAME" key followed by the "ENTER" key to proceed to the next game or, if you wish to exit the session, press the "SPECIAL" key and then the "EXIT" key and then the "ENTER" key.

**I. Quick Reference Guide**  
**-Verifying a Bingo**

1. Press the "VERIFY" key.
2. If you are verifying standard Capitol\UniMax bingo paper proceed to step #3. If you are verifying Capitol paper other than the standard bingo paper Press the "SPECIAL" key followed by the number corresponding to the type of bingo paper series that you wish to verify using the numeric keypad.
3. Enter the free-space number from the bingo card face of the person who called "BINGO," using the numeric keypad, then press the "ENTER" key.
4. Press the "ENTER" key again if you wish to verify other bingos called in that game and repeat step #2.
5. Press the "W" key to calculate the payout to each winner, followed by the "ENTER" key.
6. To exit the verify mode, press the "ENTER" key followed by the "CANCEL" key.

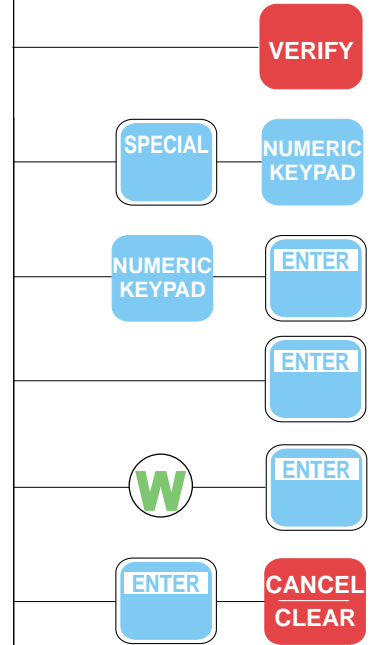

## V. Special Functions



*Note: Another way to enter a wild number is to press the ball switch(es) with your finger. Keep the switch depressed until you hear a beep. The number will light up on the flashboard. Continue to press additional ball switch(es) as needed for multiple wild numbers.*



*Note: The wild-number feature may be temporarily used to override a defective ball tray switch.*

### A. Testing the System

1. Press the "SPECIAL" key.
2. Press the "TEST" key.  
All flashboard lights will illuminate.

The display will read:

TESTING FLASHBOARDS

PRESS ANY KEY TO  
RETURN TO SYSTEM

3. Press the "ENTER" to leave the testmode.

### B. Entering a Wild Number

1. Press the "SPECIAL" key.
2. Press the "WILD #" key.

The display will read:

WILD NUMBER OPTIONS

\* ENTER A NUMBER  
\* PRESS 'W' + NUMBER  
\* ENTER NUMBER + 'W'  
\* PRESS 'D' FOR ODDS  
\* PRESS 'S' FOR EVENS

PRESS 'SPECIAL' THEN  
'EXIT' TO RESUME

ENTRY:

3. Wild number options:
  - a. Enter any 2-digit number for a single wild number.
  - b. Use "W" before a single digit to call all balls ending in that digit.  
For example: (W3=3,13,23,33,.....73)
  - c. Use "W" after a single digit to call all double-digit ball numbers beginning with that digit.  
For example: (3W=30,31,32,.....39)
  - d. Use "D" to call all odd numbers.
  - e. Use "S" to call all even numbers.
4. Enter as many wild numbers as you desire and then press the "ENTER" key.

5. When finished, press the "SPECIAL" key and then the "EXIT" key to exit this mode.

The display will read:

*** MANUAL GAME: 1	
DOLLAR VALUE: 0	
PATT: 0<	BINGO
0	. . . . .
0	. . . . .
0	. . . . .
0	. . . . .
0	. . . . .
LAST CALL: 73	TIMER
# of BALLS: 8	= 0



## C. Tear Open Save and Recall

### 1. Saving a Tear Open Game

After calling a specified number of balls (typically 40-45):

TEAR OPEN GAME SAVED  
PRESS ANY KEY  
TO CONTINUE

a. Press the "SPECIAL" key.

b. Press the "SAVE" key.

The display will read:

The game will be saved.

c. Press the "ENTER" key.

d. Press the "NEXT GAME" key.

e. Press the "ENTER" key.

### 2. Recalling a Tear Open Game

a. Press the "SPECIAL" key.

b. Press the "RECALL" key.

The display will read:

c. Press the "ENTER" key to resume the tear open game.

All data will be restored and all flashboards will display the Tear Open game information.

### D. Delete the Winning Pattern Shown on the Verifier Screen.

This feature allows game patterns to be grouped together during programming when one pattern does not always bingo out before another. This feature also allows all the possible combinations of a game pattern to be played. For example playing for any horizontal line will allow you to play until all five possible combinations have been bingoed on. An additional feature is the ability to check for multiple winners on a given bingo card face.

VERIFY OPTIONS:  
D = DAB ALL PERM  
W = WIN TALLY  
S = ERASE WIN PATTERN  
CANCEL = RETURN  
ENTER ANY STANDARD  
FACE NUMBER:

a. After verifying a valid bingo, press the "ENTER" key to return to the verify options screen.

The display will read:

*Note: Tear Open flashboards will retain balls called while Bingo flashboards will clear for next regular game.*

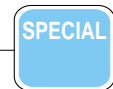
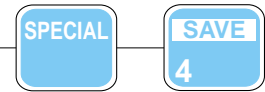



- b. Press the "S" key.
- c. Repeat steps A and B until all bingo's have been verified and winning patterns have been deleted.
- d. Press the "CANCEL" key to continue the current game.

**E. Game Recall (Resume Previous Game)**

This feature allows in Auto Mode only to recall the previous game with all game parameters and balls called prior to the first ball being called in a new game.

For example, if the caller accidentally presses the "NEXT GAME" key followed by the "ENTER" key, the caller has the ability to resume the previous game.

- 1. Press the "SPECIAL" key.
- 2. Press the "RESUME" key.
- 3. Resume playing the previous game.

**F. Speed Bingo**

This feature allows in Manual Mode (only) to play the same game many times in succession with minimal effort.

- 1. Clear the ball tray.
- 2. Press the "SPECIAL" key.
- 3. Press the "RESUME" key.

The flashboard will clear and increment the game number by one, game pattern(s), dollar value and ball timer value will remain the same.

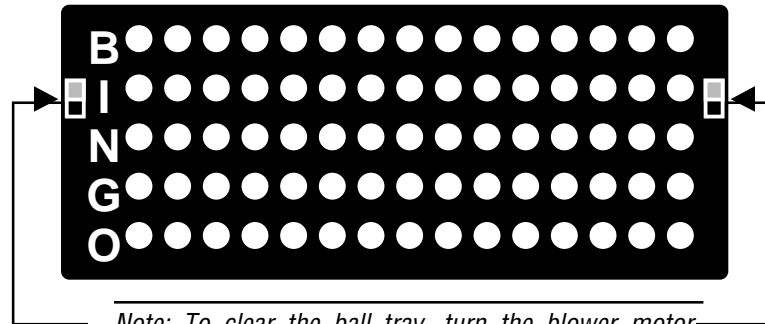

*Note: To clear the ball tray, turn the blower motor switch off, push the ball tray release tabs fully forward and open the gate to return the balls to the ball mixing chamber.*

**G. Printed Audit Trail and Summary of Balls Called  
(with optional Printer)**

**1. Audit Trail: Prints out all vital game statistics.**

- a. Be sure the printer is installed with an ample supply of paper, the communications cable is installed properly, the power switch is on and the printer is "ON LINE."
- b. The printing of the Audit Trail is automatic with play of the bingo session.

*Statesman Bingo System by  Arrow*

**Session: 3 Game: 6 Time: 8:21 Date: 7-1-93**

ROT	BALL	TIME	ROT	BALL	TIME	ROT	BALL	TIME	ROT	BALL	TIME
1	#62	8:21	2	#22	8:21	3	#3	8:21	4	#16	8:22
5	#57	8:22	6	#27	8:22	7	#12	8:23	8	#75	8:23
9	#40	8:23	10	#9	8:24	11	#72	8:24	12	#11	8:24
13	#29	8:25	14	#73	8:25	15	#48	8:25	16	#31	8:26
17	#38	8:26	18	#46	8:26	19	#13	8:27	20	#70	8:27
21	#49	8:27	22	#26	8:28	23	#53	8:28	24	#47	8:28

**VERIFY 8:29 Face:45000 WINNER**

B	I	N	G	O	PATTERN
3	16	42	46	70	■ ■ ■ ■ ■
13	26	31	57	75	■ ■ ■ ■ ■
11	29		53	73	■ ■ ■ ■ ■
12	22	40	47	62	● ● ● ● ●
9	27	38	49	72	■ ■ ■ ■ ■

**2. Summary of Balls Called: Prints out the frequency of each ball called during the current play of bingo.**

The summary is valid for the duration that the machine is on. Each time the system is turned off, the ball summary memory is cleared. If in the manual game mode, proceed to step b, if not...

- a. Press the "SPECIAL" key followed by the "EXIT" key and then the "ENTER" key to change to the manual gamemode.

\*\*\*\*\*SUMMARY OF BALL TRAY ACTIVITY\*\*\*\*\*

BALL	COUNT	BALL	COUNT	BALL	COUNT	BALL	COUNT	BALL	COUNT
# 1	14	# 2	21	# 3	8	# 4	6	# 5	22
# 6	8	# 7	15	# 8	6	# 9	6	#10	13
#11	12	#12	7	#13	4	#14	9	#15	6
#16	3	#17	16	#18	9	#19	14	#20	14
#21	7	#22	7	#23	16	#24	20	#25	18
#26	17	#27	4	#28	21	#29	4	#30	20
#31	6	#32	11	#33	13	#34	17	#35	7
#36	14	#37	8	#38	5	#39	11	#40	11
#41	9	#42	15	#43	11	#44	10	#45	9
#46	6	#47	15	#48	9	#49	7	#50	17
#51	10	#52	14	#53	23	#54	9	#55	17
#56	12	#57	5	#58	13	#59	4	#60	12
#61	13	#62	9	#63	8	#64	16	#65	4
#66	11	#67	5	#68	10	#69	15	#70	9
#71	8	#72	11	#73	16	#74	8	#75	21

- b. Press the "SPECIAL" key.
  - c. Press the "PRINTER" key.
- The display will read:
- 
- The hard copy will print:

*Note: This function is only available in the manual game mode.*

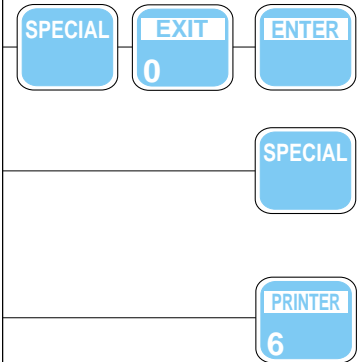

*Note: Time and date programming is available only in the manual game mode or at the time of power-up.*



*Note: Enter data as 2-digit numbers, for example, "01" or "90." When the sequence is complete, the system will return to the manual game screen.*



## H. Time & Date Programming

Time and date programming is required only if using the optional printer.

### 1. Programming the Date

- Press the "SPECIAL" key.
- Press the "CLOCK" key.

The display will read:

PRESS 'D' FOR DATE  
OR 'ENTER' FOR TIME

- Press the "D" key for date and the system will prompt you for the following:  
Month  
Day  
Year
- Use the numeric keypad to enter the requested information, being careful to use two digit numbers only (i.e. "0" - "1" for 1).
- Follow each entry with the "ENTER" key.

### 2. Programming the Time

- Press the "SPECIAL" key.
- Press the "CLOCK" key.

The display will read:

PRESS 'D' FOR DATE  
OR 'ENTER' FOR TIME

- Press the "ENTER" key for time and the system will prompt you for the following:  
Hour (use 24-hour military time)  
Minute
- Use the numeric keypad to enter the requested information, being careful to use two digit numbers only (i.e. "0" - "1" for 1).
- Follow each entry with the "ENTER" key.

All values that are entered are permanently saved and automatically updated with time in the system memory. Operators may change or reset the time and date at their discretion.

## I. Changing the Ball Timer Mode

When the power is turned on, the Statesman Color system is automatically set for the ball activated mode. The timer will reset only when a ball is inserted into the ball tray. The timer mode toggles between constant and ball activated as is described below, in the manual mode only.

### 1. Constant timer mode

- a. If in the manual game mode proceed to step b, if not press the "SPECIAL" key followed by the "EXIT" key and then the "ENTER" key to change to the manual game mode.

- b. Press the "SPECIAL" key.
- b. Press the "AUTO" key.

The display will read:

- d. Press the "ENTER" key to return to manual game mode and actuate the ball timer

### 2. Ball-activated mode

- a. If in the manual game mode proceed to step b, if not, press the "SPECIAL" key followed by the "EXIT" key and then the "ENTER" key to change to the manual game mode.

- b. Press the "SPECIAL" key.
- c. Press the "AUTO" key.

The display will read:

- d. Press the "ENTER" key.

CONSTANT TIMER MODE  
SELECTED - PRESS ANY  
KEY TO RETURN

BALL ACTIVATED MODE  
SELECTED - PRESS ANY  
KEY TO RETURN



*Note: If the system prompts you with a message "This option not available," press any key to return to the game session. Consult your distributor to order this option if it is legal in your jurisdiction.*

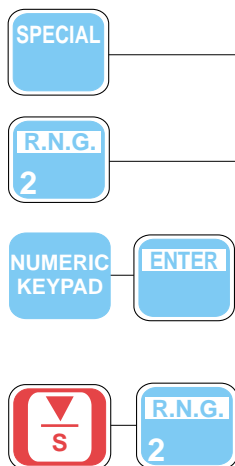

## J. Auto Call or Random-Number Generator (optional feature)

When this mode is selected, the on-board computer will randomly choose a user selected number of balls. There are two modes of operation, either automatic or manual calling of balls. When the RNG is in operation a computer generated image of the ball will appear on any hall monitors that are connected to the system. In order to operate properly the RNG must be selected during set up. **Refer to note.**

ENTER TOTAL NUMBER OF BALLS TO CALL  
ENTRY :

### Mode One - Auto Call Operation

1. Press the "SPECIAL" key.
2. Press the "RNG" key.

The display will read:

3. Enter the total number of balls to be called from 1-75, using the numeric keypad.
4. Press the "ENTER" key. The system will now call the number of balls you've chosen. Call speed is determined by the pre-programmed ball timer.
5. Press the "S" key to shut off the RNG feature.
6. Continue starting with step #1 to reactivate the random number generator if necessary.

### Mode Two - Manual Call Operation

1. Press the "SPECIAL" key.
2. Press the "RNG" key.

The display will read:

3. Press the "ENTER" key.
4. Press the "W" key each time you wish a number to be called corresponding to your pre-programmed ball timer interval.



ENTER TOTAL NUMBER OF BALLS TO CALL  
ENTRY :

---

## VI. Service

---

### A. Cleaning Your Statesman Color Bingo System

Periodic servicing of your Statesman Color Bingo System should include cleaning, polishing and light bulb replacement. Recommended cleaning agents for the console and flashboard areas follows:

#### Console, Wood Surface

Use any high-quality wood and furniture polish. Liberally apply with a clean soft cloth. Polish frequently.

#### Console, Painted Metal Surface

Use a mild soap solution or mild cleanser. Harsh cleansers or solvents may damage the paint or lettering. Follow with an automotive-style polish for additional protection.

#### Console and Flashboard, Acrylic Surfaces

Use only a mild soap solution such as liquid detergent with a clean soft cloth for best results and protection of the surfaces.

#### Flashboard, Brass Anodized Aluminum Extruded and Painted Metal Surfaces

Use a mild soap solution or mild cleanser. Harsh cleansers or solvents may damage the paint or lettering. Follow with an automotive-style polish for additional protection.

#### Bingo Balls

Clean with a mild soap solution such as a liquid detergent. Harsh cleansers or solvents may damage finish or lettering. Dry the balls thoroughly using a towel. Insert towel-dried balls into a paper bag with a small amount of talcum powder, agitate the balls and shake off the excess powder.

#### Static Treatment

Lightly spray anti-static aerosol compound over the blower base pan foam and inside the blower chamber windows to eliminate static. **(Caution: Be sure not to apply anti-static compound to the ball-catcher acrylic tube – this may cause the ball tube to shatter.)** Perform this treatment every few months or when you notice balls sticking together or to the windows.

---

**Caution: Always unplug the Color Statesman console and flashboard before performing any type of maintenance.**

---

---

*Note: Old English® brand furniture polish may be used to cover or hide any minor wood surface imperfection.*

---

---

**Caution: The front of the flashboard acrylic is a painted surface.**

---

**Caution: Always unplug the Statesman console and flashboard before performing any type of maintenance.**

**Caution: Always turn the power off when changing light bulbs.**

## B. Changing the Mixing Chamber Light bulb

1. Unlock and open the right hand side blower compartment door.
2. Remove the acrylic panel covering the lamp by turning the two plastic retaining tabs 180° for clearance.
3. Turn and unscrew the light bulb counter-clockwise to remove it.
4. Insert the new light bulb and turn it clockwise until it is snug. Do not over-tighten the light bulb.
5. Replace the acrylic cover and lock it into position with the two plastic retaining tabs.
6. Close and lock the blower compartment door.

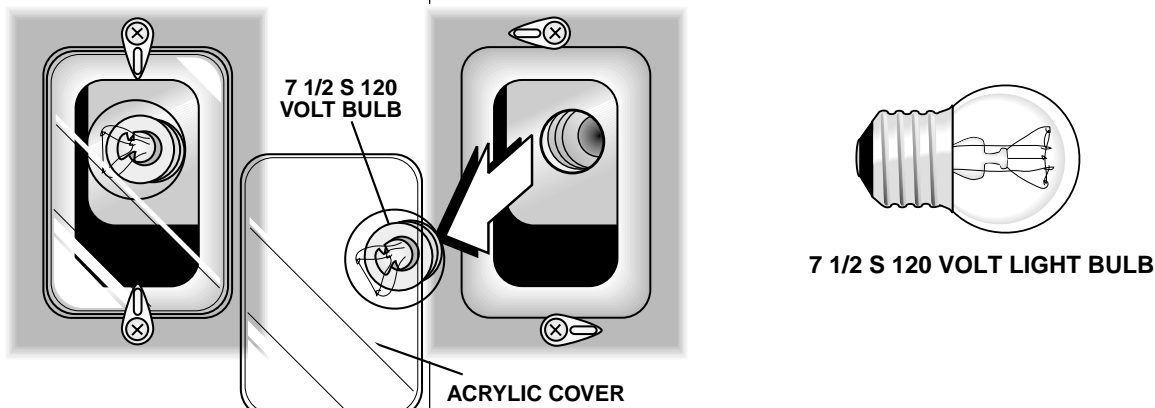

## C. Changing Light Bulbs in the Flashboard

### 1. Metal Fabricated Style Flashboards

#### a. Low Side Light Bulbs(B-7):

Remove three Phillips screws from the front of the power pack panel, swing the hinged panel open to the left and slide out the acrylic panel approximately 6 inches. Firmly grasp the acrylic panel in the center of both ends and gently bow out of the metal frame. (Refer to drawing A.) Change the light bulb(s) as necessary. (Refer to Section C-3 p. 58).

#### b. High Side Light Bulbs (8-15):

Remove the metal trim from the right end of the flash board by removing the five Phillips screws. Gently slide the acrylic panel to the right. (Refer to drawing A.) Change the light bulb(s) necessary. (Refer to section C-3 p. 58).

#### c. Game Pattern Indicator:

Remove three Phillips screws from the front of the power pack panel and swing the hinged panel to the left. Gently slide the acrylic panel out to the right. (Refer to drawing A.) Change the light bulb(s) as necessary. (Refer to Section 3 - Changing Light Bulbs p.58).

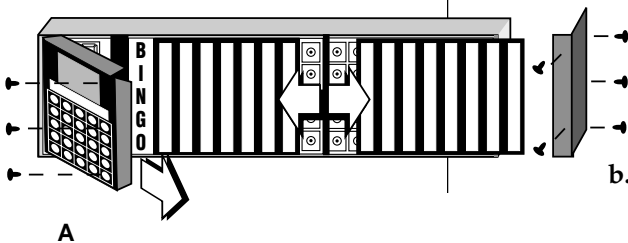



**2. Brass Anodized Aluminum Extruded Style Flashboards/ Access Flashboards**

**a. 2" and 4" large numbered flashboards:**

1. Remove the retaining strip next to the vertical bingo lamps. This is accomplished by gently pushing in the low side acrylic panel while grasping the retaining strip and gently pulling it out and to the right. (Refer to drawing B.) Once the strip is removed, slide the acrylic panels to gain access to the light bulbs needing replaced. (Refer to drawing C).
2. Change the light bulb(s) as necessary. (Refer to Section 3 - Changing Flashboard Light Bulbs, p. 58).
3. Slide the acrylic panels to their home position.
4. Re-insert the retaining strip.

**b. 8" and 12" large numbered flashboards:**

1. Open individual acrylic panels by locating the two  $\frac{1}{4}$  turn fasteners for each panel and twisting each a  $\frac{1}{4}$  turn counter-clockwise while gently pushing in. Note: Power Pack/Game Indicator sections require the use of a Phillips screwdriver. (Refer to drawing D.)
2. Gently open the acrylic panels allowing the velcro tabs to release.
3. Change the light bulb(s) as necessary. (Refer to section 3 Changing Flashboard Light Bulbs p. 58)
4. Close the acrylic panels and apply gentle pressure to lock the velcro tabs.
5. Lock the acrylic panels in place by gently pushing in the  $\frac{1}{4}$  turn fastener, compressing the spring and twisting  $\frac{1}{4}$  -turn clockwise.

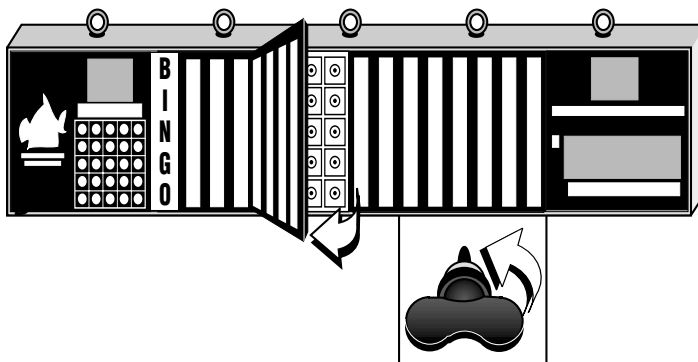

**Caution: Always unplug the Statesman console and flashboard before performing any type of maintenance.**

**Caution: Always turn the power off when changing light bulbs.**

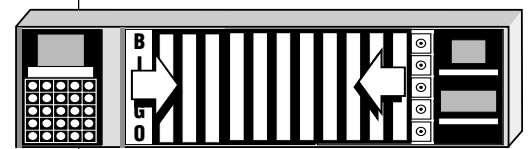
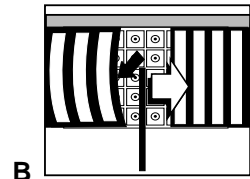

**C**

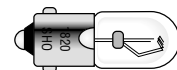

**28-VOLT  
MINIATURE BAYONET  
LIGHT BULB**

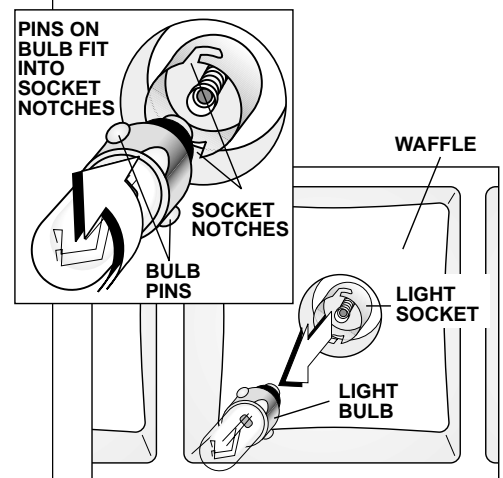

**Caution:** Always unplug the Statesman console and flash-board before performing any type of maintenance.

**Caution:** Always turn the power off when changing light bulbs.

**Caution:** Always unplug the Color Statesman console and flash-board before performing any type of maintenance.

### 3. Changing Flashboard Light Bulbs

1. Gently push light bulb in while turning counter-clockwise. Socket is spring loaded and only requires a  $\frac{1}{4}$  turn to release the light bulb from the socket.
2. Remove the light bulb from the socket.
3. Insert the new light bulb by aligning light bulb pins with the light socket notches and gently pushing in and turning clockwise. Twist a  $\frac{1}{4}$  turn to secure the light bulb in place.
4. Additional light bulbs may be purchased from your Arrow distributor or a local electrical or electronics supply house. We recommend using only high quality replacement light bulbs for extended life and to minimize the chance of printed circuit board failures.

When ordering replacement light bulbs for 2" high number-style flashboards, ask for #1829 28-volt miniature bayonet light bulbs.

When ordering replacement light bulbs for all other electronic flashboards, ask for #1820 28-volt miniature bayonet light bulbs.

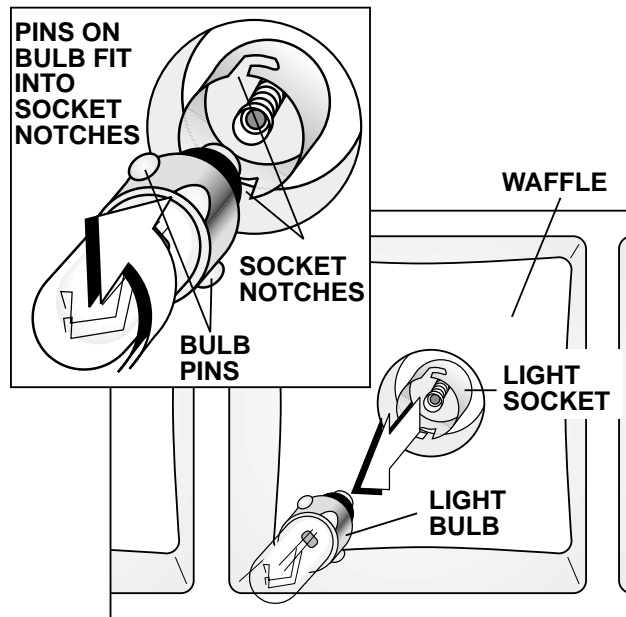
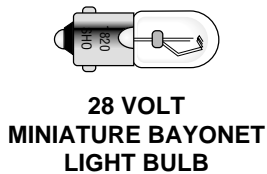

#### D. Servicing the Blower and Mixer Base Pan Assembly:

The blower motor and mixer motor should be serviced every four months or every 200 operating hours.

1. Unplug the console cord from the wall outlet.
2. Unlock and open the right-hand-side blower compartment door. Remove any balls that may be on the blower base pan assembly.
3. Disconnect the power plug located below the blower base pan and pull the assembly out of the console.
4. Lay the removed blower base pan assembly upside down on a flat surface, remove the four Phillips screws (two from each side) from the protective guard, and flip the protective guard on its side.
5. Put a few drops of 20W oil into the two oiling ports located on the top side at each end of the blower motor. (Refer to illustration.)
6. Oil the mixer motor by removing the two  $\frac{1}{4}$ " bolts from the rear plate of the mixer motor. Oil the felt pad with 20W oil, replace plate and reinsert the bolts, being careful not to overtighten them.
7. Check the blower motor squirrel cage blades for debris. If dirty, loosen the cage from the shaft with an  $\frac{1}{8}$ " Allen wrench and remove from the shaft. Clean the blades with a small stiff brush, using soap and water, towel dry. Reinstall the squirrel cage and check that the blades are free wheeling and not binding.
9. Re-assemble and carefully slide back into the console with the mixer arm pointing towards the front of the console.
10. Inspect the air filter and replace if necessary.
11. Make sure to re-connect the four-pin power plug, bingo balls into blower base pan assembly, close and lock blower compartment door.

**Caution: Always unplug the Color Statesman console and flash-board before performing any type of maintenance.**

#### NEW STYLE BLOWER ASSEMBLY

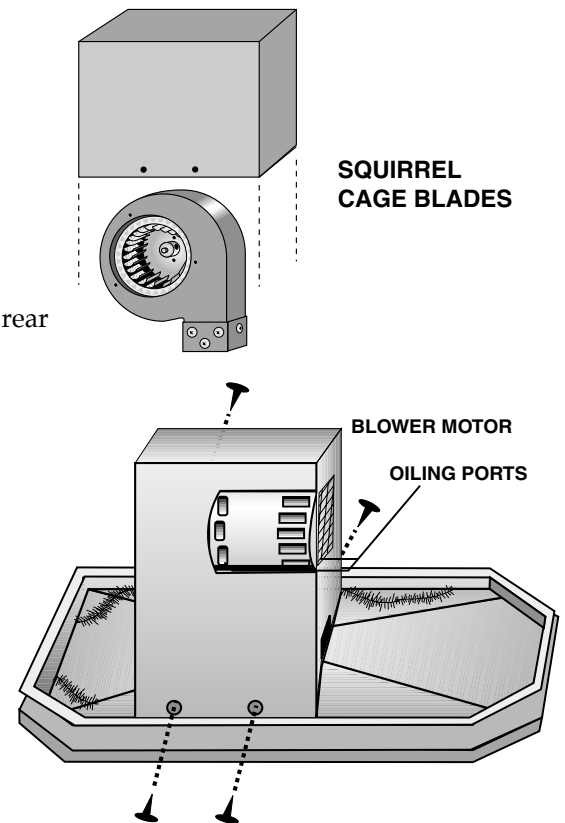

#### OLD STYLE BLOWER ASSEMBLY

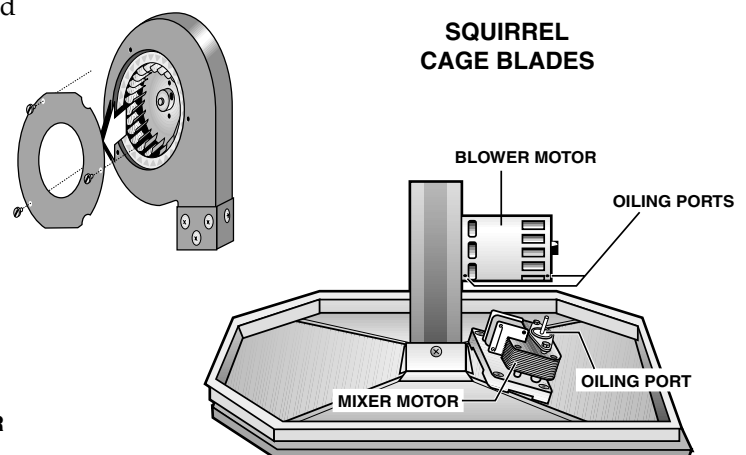

#### 4-PIN POWER PLUG ASSEMBLY

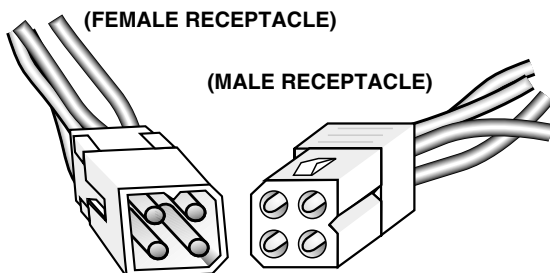

- PIN 1 (GREEN) GND      PIN 2 (WHITE) MIXER MOTOR  
 PIN 3 (WHITE) BLOWER MOTOR      PIN 4 (BLACK) NEUTRAL

---

## E. Troubleshooting

This troubleshooting section will help you, your distributor or a local electrician locate electrical problems that may arise with the Statesman Color Bingo System. Several diagrams and schematics have been included to help you trace any problems that may occur. Problems that are not covered in this section should be directed to your local distributor or directly to Arrow International as listed on p. 79. Please have the unit's serial number and distributor name readily available when calling for assistance.

Before referring to the troubleshooting table, please check to see that the following conditions are met:

1. Check that all power and data connections to the system are properly installed. Look for loose connectors or broken wires. Do not attempt to service the control panel in the Color Statesman console. Only trained service personnel are qualified to work in this area.
2. If flashboard difficulties arise, check the power and data cable connections to the flashboard. If power is being supplied to the flashboards, either the vertical BINGO lamps or the horizontal lamps for the game number display should be on. If these lamps are not on, check the primary power to the flashboards.
3. If flashboard primary power is present, run the TEST function (refer to section A, p. 48) at the Statesman Color console. When TEST is selected, the system will illuminate all light bulbs on the flashboard. On the newest Capitol flashboards, a diagnostic self-test runs at power-up.
4. Consult the Troubleshooting Table (pp. 61-65)
5. If further difficulties arise, consult the factory service center or an authorized distributor as listed on p. 79.

The Troubleshooting Table begins on the next page.

This manual was accurate at the time of printing. Arrow International reserves the right to make changes due to changing technology and regulations. Please consult your distributor or Arrow International Inc.

**Statesman Color Console Troubleshooting Table - Part 1**

PROBLEM	CAUSE	CORRECTIVE ACTION
<ul style="list-style-type: none"> <li>No console power:</li> </ul>	<ul style="list-style-type: none"> <li>Tripped service breaker</li> <li>Blown primary fuse</li> <li>Unit not plugged in</li> <li>Defective power outlet</li> </ul>	<ul style="list-style-type: none"> <li>Reset service breaker</li> <li>Replace with 6-AMP AGC-3AG 250V style fuse</li> <li>Plug system into 120V AC 60HZ grounded power outlet</li> <li>Have electrician repair unit as is deemed necessary</li> </ul>
<ul style="list-style-type: none"> <li>No blower action:</li> </ul>	<ul style="list-style-type: none"> <li>Blower motor switch off</li> <li>Blown 6-AMP fuse</li> <li>Defective blower motor</li> <li>Blower connector loose</li> <li>Defective blower switch</li> <li>Low line voltage</li> </ul>	<ul style="list-style-type: none"> <li>Turn blower motor switch on</li> <li>Replace fuse with 6-AMP AGC-3AG 250V style fuse</li> <li>Replace blower motor with Arrow part #41620</li> <li>Re-seat connectors (refer to section D, p. 59)</li> <li>Replace blower switch with Arrow part # 42523</li> <li>Consult electrician</li> </ul>
<ul style="list-style-type: none"> <li>No mixer action:</li> </ul>	<ul style="list-style-type: none"> <li>Mixer motor switch off</li> <li>Defective mixer motor</li> <li>Blower connector loose</li> </ul>	<ul style="list-style-type: none"> <li>Turn mixer motor switch on</li> <li>Replace the mixer motor with Arrow part #41630</li> <li>Re-seat connectors (refer to section D, p. 59)</li> </ul>
<ul style="list-style-type: none"> <li>Primary fuse blown:</li> </ul>	<ul style="list-style-type: none"> <li>Defective fuse</li> <li>Defective blower motor</li> <li>Defective mixer motor</li> </ul>	<ul style="list-style-type: none"> <li>Replace fuse with 6-AMP AGC-3AG 250V style fuse</li> <li>Replace the blower motor with Arrow part #41620</li> <li>Replace the mixer motor with Arrow part #41630</li> </ul>
<ul style="list-style-type: none"> <li>Power fuse blown:</li> </ul>	<ul style="list-style-type: none"> <li>Defective fuse</li> <li>Defective PCB</li> </ul>	<ul style="list-style-type: none"> <li>Replace fuse with .1-AMP MDL 250V style fuse</li> <li>Replace ALS PCB</li> </ul>
<ul style="list-style-type: none"> <li>No computer power:</li> </ul>	<ul style="list-style-type: none"> <li>Power switch off</li> <li>Defective switch</li> <li>Wiring harness loose</li> </ul>	<ul style="list-style-type: none"> <li>Turn power switch on</li> <li>Replace switch with Arrow part #42523</li> <li>Re-seat connectors (refer to drawing B, p. 67)</li> </ul>
<ul style="list-style-type: none"> <li>No keypad response:</li> </ul>	<ul style="list-style-type: none"> <li>Keyboard not plugged in</li> <li>Keyboard harness loose</li> <li>Inoperative keypad switch(es)</li> <li>PCB defective</li> </ul>	<ul style="list-style-type: none"> <li>Re-seat keypad connector (refer to drawing B, p. 67)</li> <li>Re-seat keypad connector (refer to drawing B, p. 67)</li> <li>Remove keypad and clean with a plastic safe contact cleaner</li> <li>Replace ALS PCB</li> </ul>
<ul style="list-style-type: none"> <li>No flashboard operation:</li> </ul>	<ul style="list-style-type: none"> <li>System set for in-process task (e.g., TIME and DATE set)</li> <li>PCB defective</li> </ul>	<ul style="list-style-type: none"> <li>Finish operation</li> <li>Replace ALS PCB</li> </ul>
<ul style="list-style-type: none"> <li>No LCD display:</li> </ul>	<ul style="list-style-type: none"> <li>Contrast adjustment down</li> <li>LCD connector loose</li> <li>Computer not functioning</li> <li>Defective LCD display</li> </ul>	<ul style="list-style-type: none"> <li>Turn contrast up</li> <li>Re-seat connector (refer to drawing B, p. 67)</li> <li>Replace ALS PCB</li> <li>Replace LCD panel with Arrow part #41997</li> </ul>
<ul style="list-style-type: none"> <li>No beeper:</li> </ul>	<ul style="list-style-type: none"> <li>Volume adjustment down</li> <li>Beeper connector loose</li> <li>Defective beeper</li> </ul>	<ul style="list-style-type: none"> <li>Turn volume up</li> <li>Re-seat connector (refer to drawing B, p. 67)</li> <li>Replace beeper with Arrow part # 49208</li> </ul>

**Statesman Color Console Troubleshooting Table - Part 2**

PROBLEM	CAUSE	CORRECTIVE ACTION
<ul style="list-style-type: none"> <li>No response to ball insertion:</li> </ul>	<ul style="list-style-type: none"> <li>Defective ball tray switch</li> <li>Loose ribbon cable connection</li> </ul>	<ul style="list-style-type: none"> <li>Replace defective switch with Arrow part # 42504</li> <li>Check connectors on switch bars and the adapter PCB</li> </ul>
<ul style="list-style-type: none"> <li>Ball stays called after tray cleared:</li> </ul>	<ul style="list-style-type: none"> <li>Defective ball tray switch</li> </ul>	<ul style="list-style-type: none"> <li>Replace defective switch with Arrow part # 42504</li> </ul>
<ul style="list-style-type: none"> <li>No video output:</li> </ul>	<ul style="list-style-type: none"> <li>Video cable defective</li> <li>Loose or defective connectors</li> <li>Camera failure</li> <li>Monitor failure</li> <li>TV/monitor configured incorrectly</li> </ul>	<ul style="list-style-type: none"> <li>Replace or repair cable as is deemed necessary</li> <li>Check connection or replace connector</li> <li>Repair or replace camera (refer to camera manual)</li> <li>Repair or replace TV/ monitor (refer to TV/monitor manual)</li> <li>Refer to TV/monitor manual and run set up</li> </ul>
<ul style="list-style-type: none"> <li>Video scrambled:</li> </ul>	<ul style="list-style-type: none"> <li>Defective video cable</li> <li>TV system driven with incompatible video signal</li> <li>Defective AC power outlet</li> <li>Video cables run improperly</li> </ul>	<ul style="list-style-type: none"> <li>Replace or repair cable as is deemed necessary</li> <li>Insert RF modulator</li> <li>Consult local electrician</li> <li>Consult distributor or Arrow Technical support</li> </ul>
<ul style="list-style-type: none"> <li>Verifier not switching to camera:</li> </ul>	<ul style="list-style-type: none"> <li>Defective ALS PCB or video relay</li> <li>Video connections reversed</li> </ul>	<ul style="list-style-type: none"> <li>Replace ALS PCB</li> <li>Switch connections (refer to console Input/Output illustration p. 7)</li> </ul>
<ul style="list-style-type: none"> <li>Error message on power up:</li> </ul>	<ul style="list-style-type: none"> <li>Console configured incorrectly</li> </ul>	<ul style="list-style-type: none"> <li>Run set up (refer to System Setup, p. 14)</li> </ul>

**StatesmanFlashboard Troubleshooting Table - Part 1**

PROBLEM	CAUSE	CORRECTIVE ACTION
<ul style="list-style-type: none"> <li>No flashboard power:</li> </ul>	<ul style="list-style-type: none"> <li>Power switch is off</li> <li>Unit not plugged into outlet</li> <li>No voltage at power outlet</li> <li>Primary fuse defective</li> <li>Defective power switch</li> <li>Defective power transformer</li> </ul>	<ul style="list-style-type: none"> <li>Turn switch on (up position)</li> <li>Plug into a 120VAC 60HZ grounded power outlet</li> <li>Check power outlet with test lamp or voltmeter, reset circuit breaker, replace defective fuse or consult electrician</li> <li>Replace fuse with a 4 AMP SLO BLO ACG 250V style fuse</li> <li>Replace switch with Arrow part #42517</li> <li>Test transformer with a voltmeter. 28VAC should be read across the unmarked or AC terminals of the bridge rectifier (refer to bridge rectifier illustration on p. 63) If the voltage varies +/- 20%, replace transformer with Arrow part #42720</li> </ul>

**Statesman Flashboard Troubleshooting Table - Part 2**

PROBLEM	CAUSE	CORRECTIVE ACTION
<ul style="list-style-type: none"> <li>• No flashboard power cont.:</li> </ul>	<ul style="list-style-type: none"> <li>• Defective bridge rectifier</li> </ul>	<ul style="list-style-type: none"> <li>• Test bridge rectifier with a voltmeter, There should be a reading of 28VDC between the + &amp; - terminals of bridge rectifier. Replace defective bridge rectifier with (35AMP 800PIV) Arrow part #41940</li> </ul>
<ul style="list-style-type: none"> <li>• Primary fuse blown:</li> </ul>	<ul style="list-style-type: none"> <li>• Defective fuse</li> <li>• Defective socket in vertical or horizontal bingo lights</li> <li>• Defective bridge rectifier</li> <li>• Defective power transformer</li> </ul>	<ul style="list-style-type: none"> <li>• Replace fuse with a 4AMP SLO BLO ACG 250 V fuse</li> <li>• Disconnect the + lead off bridge rectifier. If fuse quits opening, examine lamp sockets for shorted sockets or crossed wires. Light socket will read about 22 ohms with meter if good (refer to bridge rectifier ill. below)</li> <li>• Remove unmarked or AC terminals from bridge. Do not let terminals touch. If fuse quits opening replace bridge rectifier with (35AMP 800PIV) - Arrow part #41940 (refer to bridge rectifier ill. below)</li> <li>• Remove unmarked terminals or AC from bridge. Do not let terminals touch. If fuse continues to open, replace power transformer with Arrow part #42720 (refer to bridge rectifier ill. below)</li> </ul>

## Bridge Rectifier

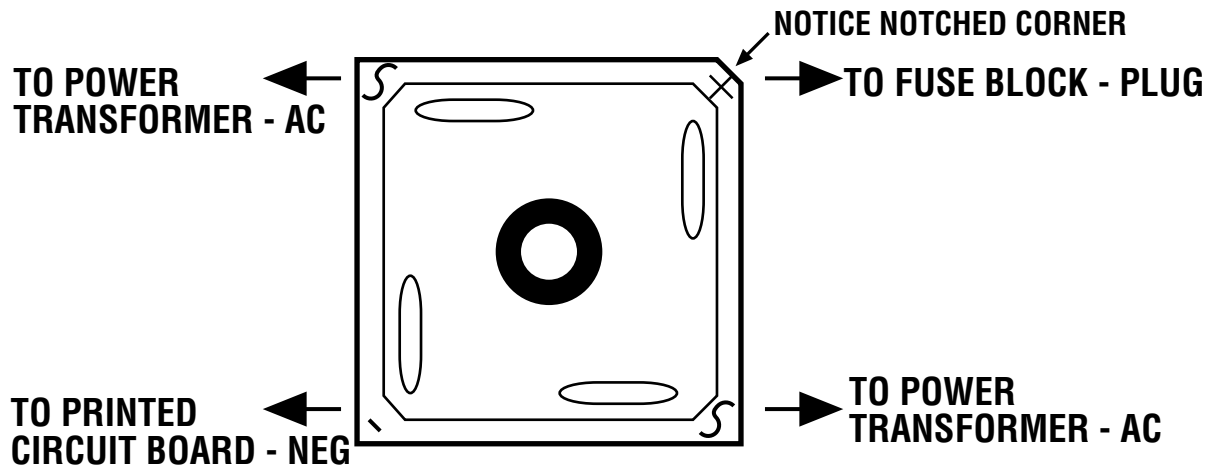

**Statesman Flashboard Troubleshooting Table - Part 3**

PROBLEM	CAUSE	CORRECTIVE ACTION
<ul style="list-style-type: none"> <li>• BINGO lamps on with no response from console:</li> </ul>	<ul style="list-style-type: none"> <li>• Defective data cable</li> <li>• 1 AMP logic fuse blown</li> <li>• Defective PCB</li> </ul>	<ul style="list-style-type: none"> <li>• Repair or replace data cable as necessary. Check for loose or dirty connections and frayed or broken wires</li> <li>• Replace fuse with a 1 AMP SLO BLO ACG 250V fuse on ACRD PCB (refer to drawing G, p. 71)</li> <li>• Replace ACRD PCB in flashboard</li> </ul>
<ul style="list-style-type: none"> <li>• No response to ball insertion in tray:</li> </ul>	<ul style="list-style-type: none"> <li>• Lamp failure</li> <li>• SCR / Darlington failure</li> <li>• Lamp socket failure</li> <li>• ACRD PCB failure</li> <li>• Defective crimp on ribbon cable</li> </ul>	<ul style="list-style-type: none"> <li>• Replace lamp in flashboard - use #1829 for 2" or #1820 for all other flashboards (Refer to Changing light bulbs in flashboard, p. 56)</li> <li>• Refer to map corresponding to style of PCB. in Section VII - Wiring Diagrams. Change SCR/Darlington. SCR's must be desoldered to be replaced. To replace a Darlington, use an IC puller or small screwdriver to gently pry the darlington out of the socket. Replace defective Darlington with Arrow part #41947. Observe notch in IC when reinstalling</li> <li>• Check connections on back of lamp socket. Use ohm meter to check for a shorted lamp socket (0 ohms) Replace defective socket. If good, meter will read about 22 ohms</li> <li>• Replace ACRD PCB</li> <li>• Check both ends of the ribbon cable, recrimp connection or replace ribbon cable as necessary</li> </ul>
<ul style="list-style-type: none"> <li>• Lamp stays illuminated when ball tray is cleared</li> </ul>	<ul style="list-style-type: none"> <li>• Defective SCR/Darlington</li> <li>• Defective ACRD PCB</li> </ul>	<ul style="list-style-type: none"> <li>• Refer to map corresponding to style of PCB in Section VII - Wiring Diagrams. Change SCR/Darlington. SCR's must be desoldered to be replaced. To replace a Darlington, use an IC puller or small screwdriver to gently pry the darlington out of the socket. Replace defective Darlington with Arrow part #41947. Observe notch in IC when reinstalling</li> <li>• Change ACRD PCB</li> </ul>



**Statesman Flashboard Troubleshooting Table - Part 6**

PROBLEM	CAUSE	CORRECTIVE ACTION
<ul style="list-style-type: none"> <li>• Flashboard blinks or lights flicker:</li> </ul>	<ul style="list-style-type: none"> <li>• Loose data cable</li> <li>• Incorrect PCB configuration</li> <li>• Defective ACRD PCB</li> <li>• Data cable installed incorrectly</li> </ul>	<ul style="list-style-type: none"> <li>• Check both ends of the data cable for loose connections or frayed wires. Replace sockets or cable as necessary</li> <li>• Refer to Darlington map for corresponding PCB configuration. Set jumpers on ACRD PCB for specific application (Refer to p. 72)</li> <li>• Replace ACRD PCB</li> <li>• Correct cabling to flashboard (refer to Flashboard Installation, p. 7)</li> </ul>
<ul style="list-style-type: none"> <li>• Lights dim:</li> </ul>	<ul style="list-style-type: none"> <li>• Dirty acrylic</li> <li>• Defective bridge rectifier</li> <li>• Low line voltage</li> </ul>	<ul style="list-style-type: none"> <li>• Refer to p. 55 for cleaning instructions</li> <li>• Check with a voltmeter. Should read 28VDC +/-20% between the + and - terminal. Replace with 35A 800 PIV Arrow part #41940 (refer to bridge rectifier ill. p 63)</li> <li>• Check grounded power outlet with voltmeter, should read above 105VAC. If you have further problems, consult an electrician</li> </ul>
<ul style="list-style-type: none"> <li>• Group of 30 lights out:</li> </ul>	<ul style="list-style-type: none"> <li>• Defective secondary fuse</li> </ul>	<ul style="list-style-type: none"> <li>• Refer to fuse map on p. 73-78. Replace with a 3.2 AMP SLO BLO AGC 250 V fuse</li> </ul>

---

## F. System Power Requirements and Fusing

**Statesman Color Console:** 120VAC @ 60HZ, 3.75 AMPS  
12 AMPS with service outlet  
Blower fuse: 6 AMP AGC-3AG 250V  
Logic power: .1 AMP MDL 250V

**2" and 4" Numbers Only Flashboard:** 120VAC @ 60HZ, 3.0 AMPS  
Primary: 4 AMP SLO BLO 250V  
Secondary: 3.2 AMP SLO BLO 250V  
Logic power: 1 AMP SLO BLO 250V

**2" and 4" Numbers and Game Ind.:** 120VAC @ 60HZ, 3.75 AMPS  
Primary: 4 AMP SLO BLO 250V  
Secondary: 3.2 AMP SLO BLO 250V  
Logic power: 1 AMP SLO BLO 250V

**2" and 4" Numbers, Game Ind. and Dollar Value Flashboard:**  
120VAC @ 60 HZ, 5.25 AMPS  
Primary: 4 AMP SLO BLO 250V  
Secondary: 3.2 AMP SLO BLO 250V  
Logic power: 1 AMP SLO BLO 250V

**8" Numbers Only Flashboard:** 120VAC @ 60HZ, 5.0 AMPS  
Primary: 4 AMP SLO BLO 250V  
Secondary: 3.2 AMP SLO BLO 250V  
Logic power: 1 AMP SLO BLO 250V

**8" Numbers and Game Indicator:** 120VAC @ 60HZ, 6.5 AMPS  
Primary: 4 AMP SLO BLO 250V  
Secondary: 3.2 AMP SLO BLO 250V  
Logic power: 1 AMP SLO BLO 250V

**8" Numbers, Game Ind. and Dollar Value Flashboard:**  
120VAC @ 60HZ, 9.5 AMPS  
Primary: 4 AMP SLO BLO 250V  
Secondary: 3.2 AMP SLO BLO 250V  
Logic power: 1 AMP SLO BLO 250V

**12" Numbers Only Flashboard:** 120VAC @ 60HZ, 9.5 AMPS  
Primary: 4 AMP SLO BLO 250V  
Secondary: 3.2 AMP SLO BLO 250V  
Logic power: 1 AMP SLO BLO 250V

**12" Numbers and Game Indicator:** 120VAC @ 60HZ, 11.5AMPS  
Primary: 4 AMP SLO BLO 250V  
Secondary: 3.2 AMP SLO BLO 250V  
Logic power: 1 AMP SLO BLO 250V

**12" Numbers, Game Ind. and Dollar Value Flashboard:**  
120VAC @ 60 HZ, 12 AMPS  
Primary: 4 AMP SLO BLO 250V  
Secondary: 3.2 AMP SLO BLO 250V  
Logic power: 1 AMP SLO BLO 250V

# VII. Wiring Diagrams

## A. Console Primary Wiring

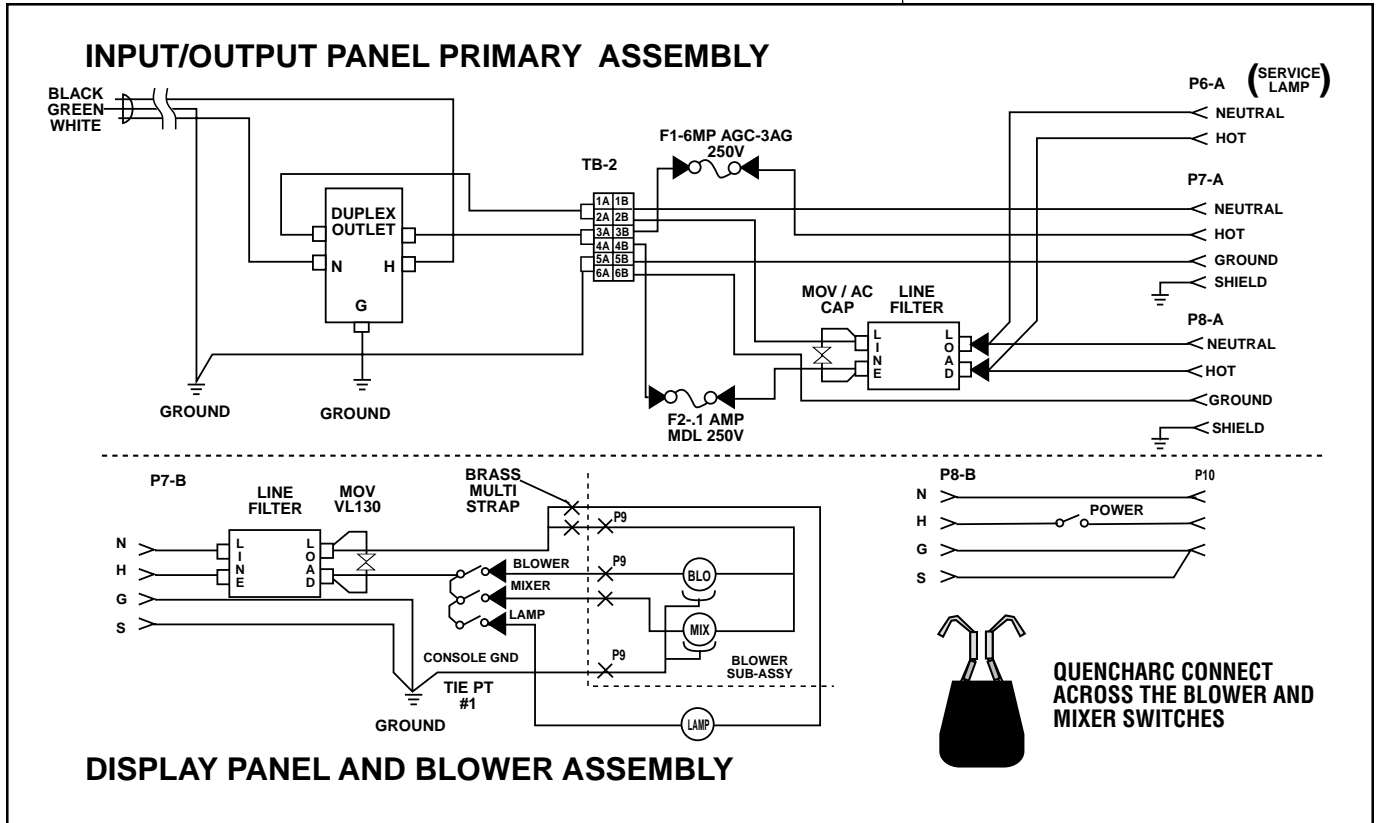

## B. Console Printed Circuit Board Connector Legend

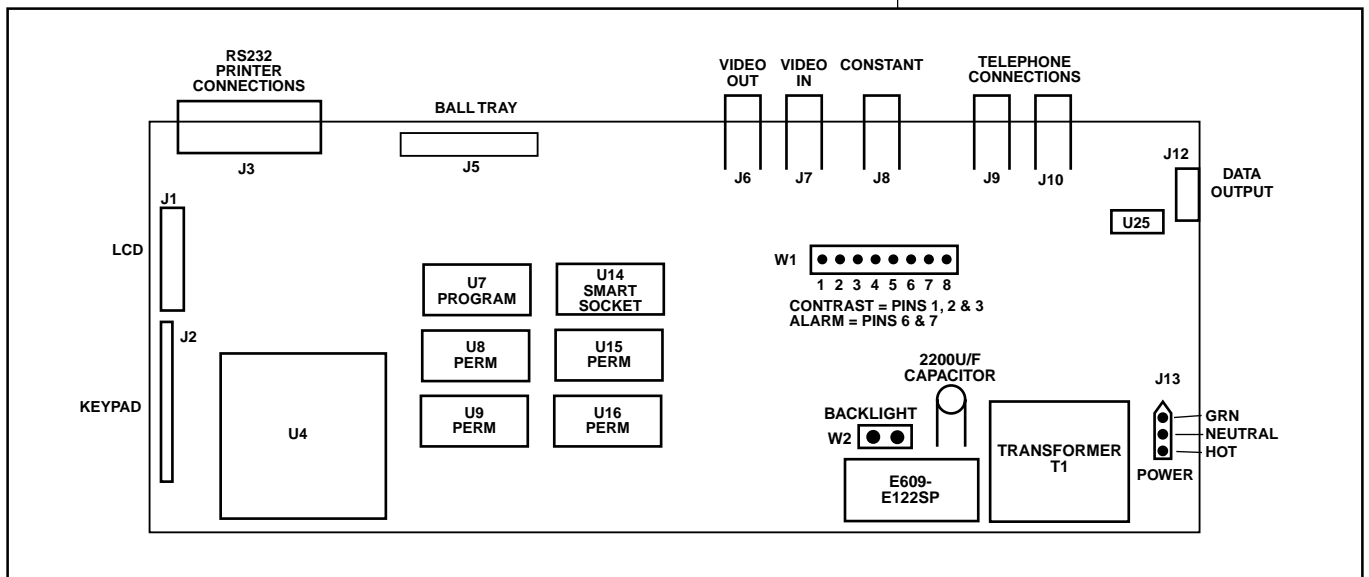

### C. Flashboard Data Cable Diagrams

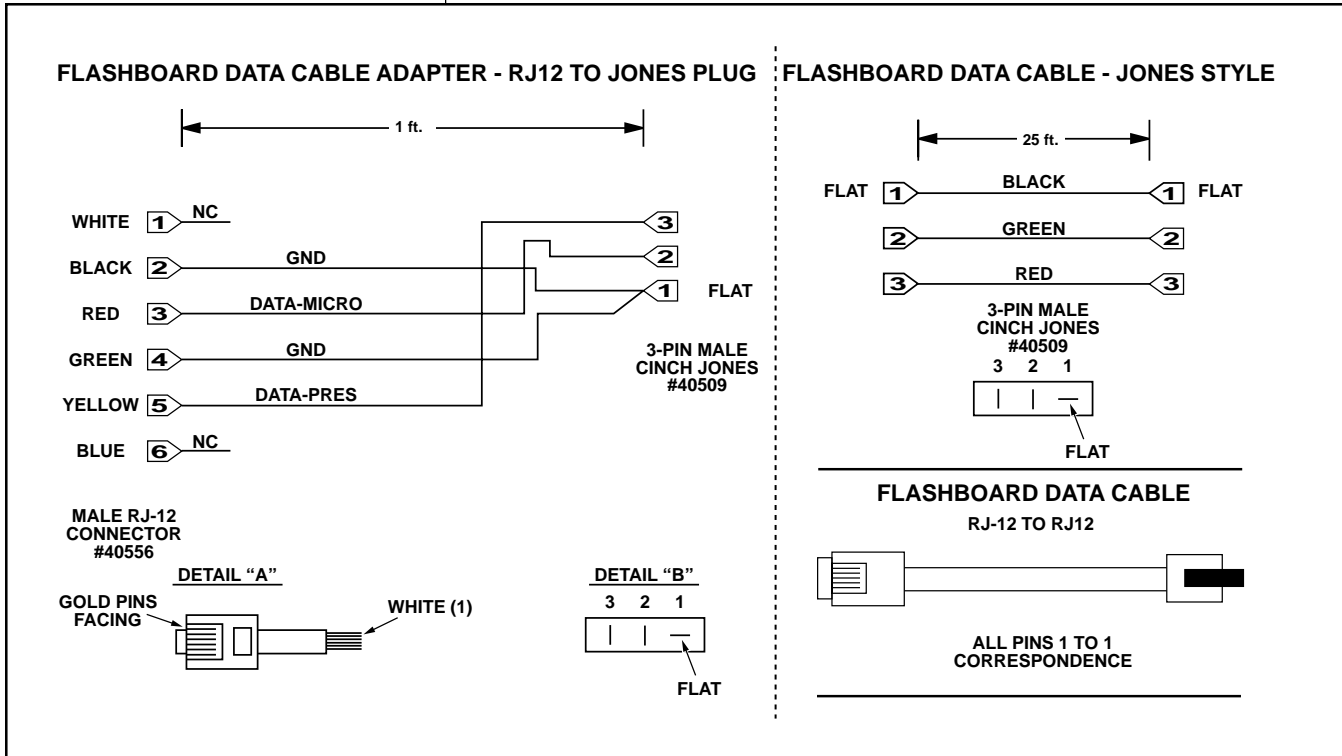

### D. AR Darlington Map

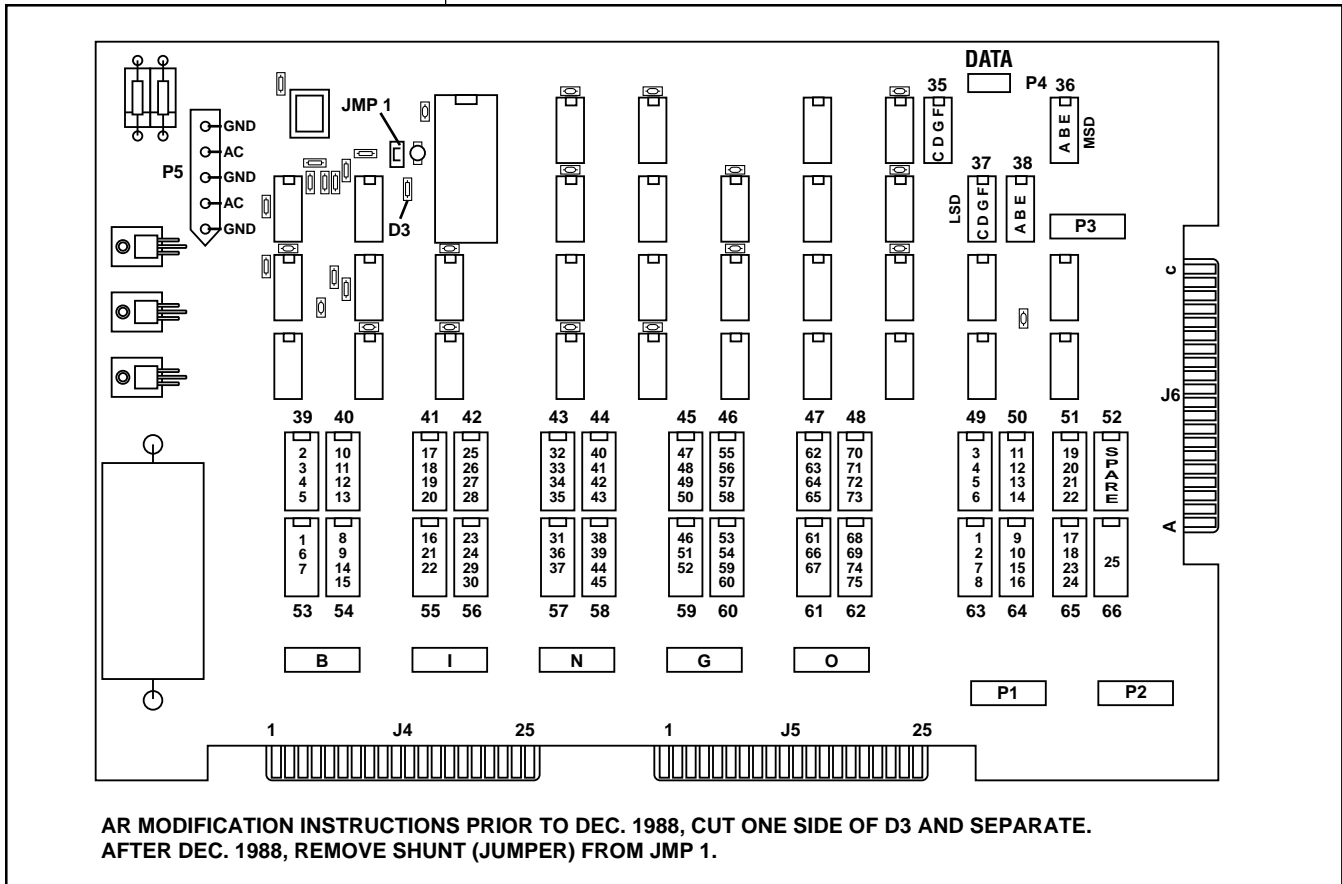

E. ACRC Darlington Map

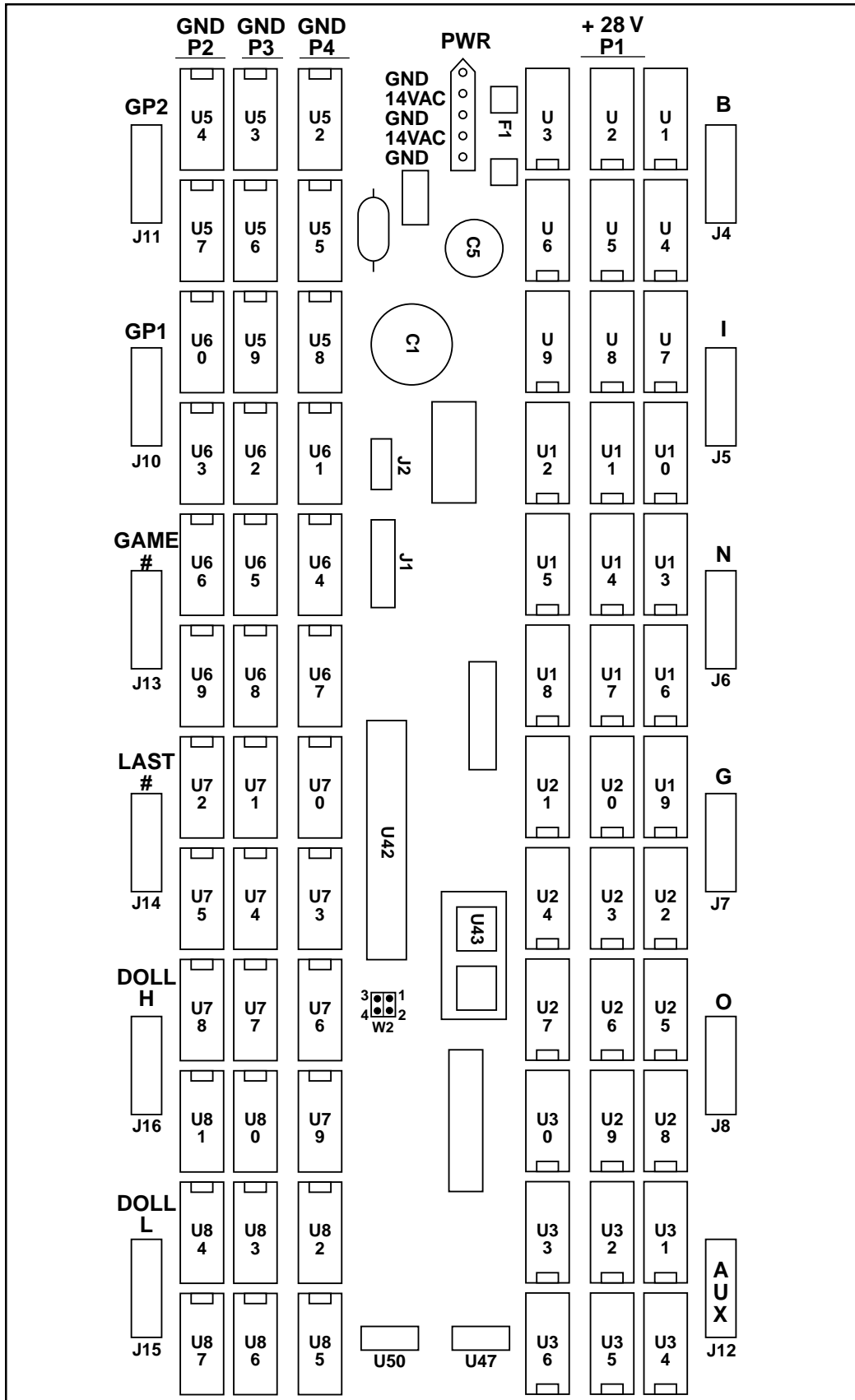

F. ACRC Darlington Map Detail

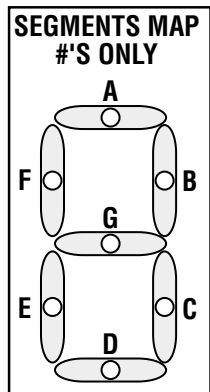

FRONT VIEW

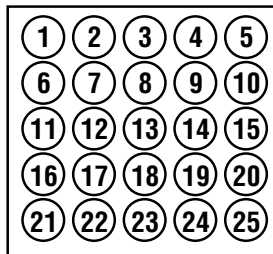

GAME PATTERN  
INDICATOR  
FRONT VIEW

LAMP NUMBERS	DRIVER (92068B)	LAMP NUMBERS	DRIVER (92068B)
<b>NUMBERS:</b>		<b>DOLLER VALUE:</b>	
B 1-4	U5	10000-B, C, E, G	U80
B 5-8	U4	10000-D, F, A	U81
B 9-12	U2	1000-B, C, E, G	U78
B 13-15	U1	1000-D, F, A	U77
I 16-19	U11	100-B, C, E, G	U86
I 20-23	U10	100-D, F, A	U87
I 24-27	U8	10-B, C, E, G	U84
I 28-30	U7	10-D, F, A	U83
N 31-34	U17	1-B, C, E, G	U32
N 35-38	U16	1-D, F, A	U31
N 39-42	U14	<b>LAST NO. CALLED:</b>	
N 43-45	U13	10'S-B, C, E, G	U74
G 46-49	U23	10'S-D, F, A	U75
G 50-53	U22	1'S-B, C, E, G	U72
G 54-57	U20	1'S-D, F, A	U71
G 58-60	U19	<b>NUMBER OF BALLS:</b>	
O 61-64	U29	10'S-B, C, E, G	U68
O 65-68	U28	10'S-D, F, A	U69
O 69-72	U26	1'S-B, C, E, G	U66
O 73-75	U25	1'S-D, F, A	U65
<b>GAME PATTERN:</b>		B-G LETTERS	U35
GP 1-4	U59	O LETTER	U34
GP 5-8	U60	<b>SPARES</b>	
GP 9-12	U62		46
GP 13-16	U63		47
GP 17-20	U53		49
GP 21-24	U54		50 & 51
GP 25	U56		
W2 1 & 2 \$ VALUE W/O SELF		REV. 2.2	JUMPER 1 & 2 FOR GAME IND.
W2 3 & 4 CONN. SELF TEST			NO JUMPER 1 & 2 FOR DOLLAR VALUE
W2 1 & 2 # & 4 \$ VALUE			JUMPER 1 & 2 FOR TIME OUT
W2 1 & 3 PRES W/O TIME OUT			NO JUMPER 3 & 4 FOR NO TIME OUT
		REV. 2.3	

**Caution: If Darlington is cracked or burnt, check the associated lamp socket and bulb before replacing the Darlington or PCB.**

G. ACRD Darlington Map

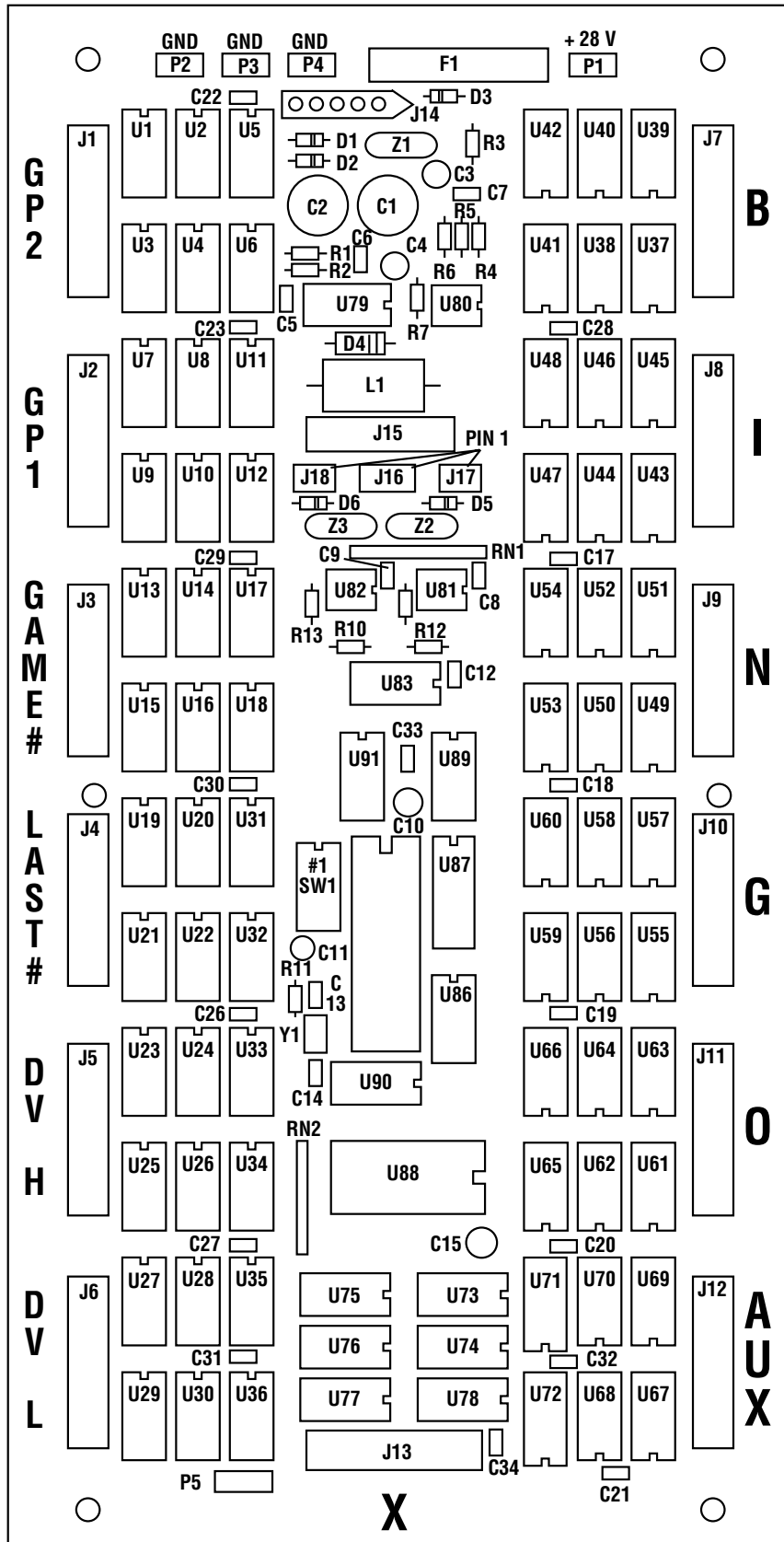

FRONT VIEW SEGMENTS

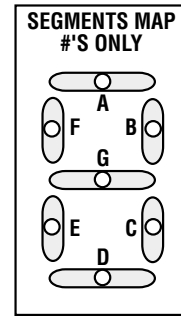

FRONT VIEW

B	I	N	G	O
1	2	3	4	5
6	7	8	9	10
11	12	13	14	15
16	17	18	19	20
21	22	23	24	25

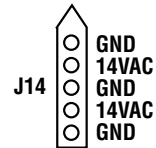

CLOSE = OFF

NOTE: FOR SENATOR AND LV3 FLASHBOARDS

---

INPUT = J18  
OUTPUT = J17

POWER OFF WHEN RESETTING ANY SWITCH ON SW1

## H. ACRD Darlington Map Detail

LAMP NUMBERS	DRIVER	LAMP NUMBERS	DRIVER	LAMP NUMBERS	DRIVER	CONFIGURATION FOR ACR REV D WITH VERSION 3.4 FIRMWARE
B1	U38	X76-78	U77	<b>GAME #</b>		<b>DIP SWITCH POSITION CONFIGURATION</b>  <b>SW 1</b> ON CONTINUOUS TEST OFF STANDARD OPERATION  <b>SW 2</b> ON LAMP SAVER DISABLED OFF STANDARD OPERATION  <b>SW 3</b> ON SMALL SYNC PACKET OFF LARGE SYNC PACKET  <b>SW 4</b> XX SEE CONFIGURATION TABLE  <b>SW 5</b> XX SEE CONFIGURATION TABLE  <b>SW 6</b> ON TIMEOUT OFF TIMEOUT DISABLED (SEE TABLE FOR OPTIONS)  <b>SW 7</b> NOT USED
B2-4	U37	X79	U76	1'S NO. BALLS A-C	U13	
B5-6	U38	X80	U77	1'S NO. BALLS D-F	U14	
B7	U37	X81-83	U76	1'S NO. BALLS G	U13	
B8	U38			10'S NO. BALLS A	U15	
B9-10	U40	X84	U78	10'S NO. BALLS B-C	U16	
B11-12	U39	X85	U74	10'S NO. BALLS D-E	U15	
B13	U40	X86-87	U78	10'S NO. BALLS F-G	U16	
B14	U39	X88-89	U74	<b>LAST #</b>		
B15	U40	X90	U78	1'S LAST A-C	U19	
		GP1	U8	1'S LAST D-F	U20	
I16	U44	GP2-4	7	1'S LAST G	U19	
I17-19	U43	GP5-6	U8	10'S LAST A	U21	
I20-21	U44	GP7	U7	10'S LAST B-C	U22	
I22	U43	GP8	U8	10'S LAST D-E	U21	
I23	U44			10'S LAST F-G	U22	
		GP9-10	U10	<b>DOLLAR H</b>		
I24-25	U46	GP11-12	U9	10K'S DV A	U25	
I26-27	U45	GP13	U10	10K'S DV B-C	U26	
I28	U46	GP14	U9	10K'S DV D-E	U25	
I29	U45	GP15	U10	10K'S DV F-G	U26	
I30	U46			1000'S DV A-C	U23	
		GP16	U9	1000'S DV D-F	U24	
N31	U50	GP17	U2	1000'S DV G	U23	
N32-34	U49	GP18-20	U1	<b>DOLLAR L</b>		
N35-36	U50	GP21-22	U2	100'S DV A	U29	
N37	U49	GP23	U1	100'S DV B-C	U30	
N38	U50			100'S DV D-E	U29	
		GP24	U2	100'S DV F-G	U30	
N39-40	U52	GP25	U4	10'S DV A-C	U27	
N41-42	U51			10'S DV D-F	U28	
N43	U52	<b>AUX</b>		10'S DV G	U27	
N44	U51	B LMP	U67	1'S DV A-D	U70	
N45	U52	I LMP	U67	1'S DV E-G	U69	
		N LMP	U68	<b>CONFIGURATION TABLE WITHOUT LOGIC TRANSFORMER</b>		
G46	U56	G LMP	U67	SENATOR-LV3 W/TIMEOUT	SW 3 XX SW 4 ON SW 5 OFF SW 6 ON	
G47-49	U55	O LMP	U68	SENATOR-LV3 W/O TIMEOUT	XX ON OFF OFF	
G50-51	U56			PRES-2001 W/TIMEOUT	ON OFF ON ON	
G52	U55			PRES-2001 W/O TIMEOUT	ON OFF ON OFF	
G53	U56			STATESMAN (GI) W/O TIMEOUT	OFF OFF ON OFF	
				STATESMAN (GI) W/ TIMEOUT	OFF OFF ON ON	
G54-55	U58	<b>SPARES</b>		STATESMAN (DV) W/O TIMEOUT	OFF OFF OFF OFF	
G56-57	U57	U3, U77, U78		STATESMAN (DV) W/ TIMEOU T	OFF OFF OFF ON	
G58	U58	<b>OUTPUT - U83</b>				
G59	U57					
G60	U58					
				(XX = DOESN'T MATTER)		
O61	U62					
O62-64	U61					
O65-66	U62					
O67	U61					
O68	U62					
O69-70	U64					
O71-72	U63					
O73	U64					
O74	U63					
O75	U64					

**Caution: If Darlington is cracked or burnt, check the associated lamp socket and bulb before replacing the Darlington or PCB.**



I. 2" FB Primary Wiring Schematic - Numbers Only

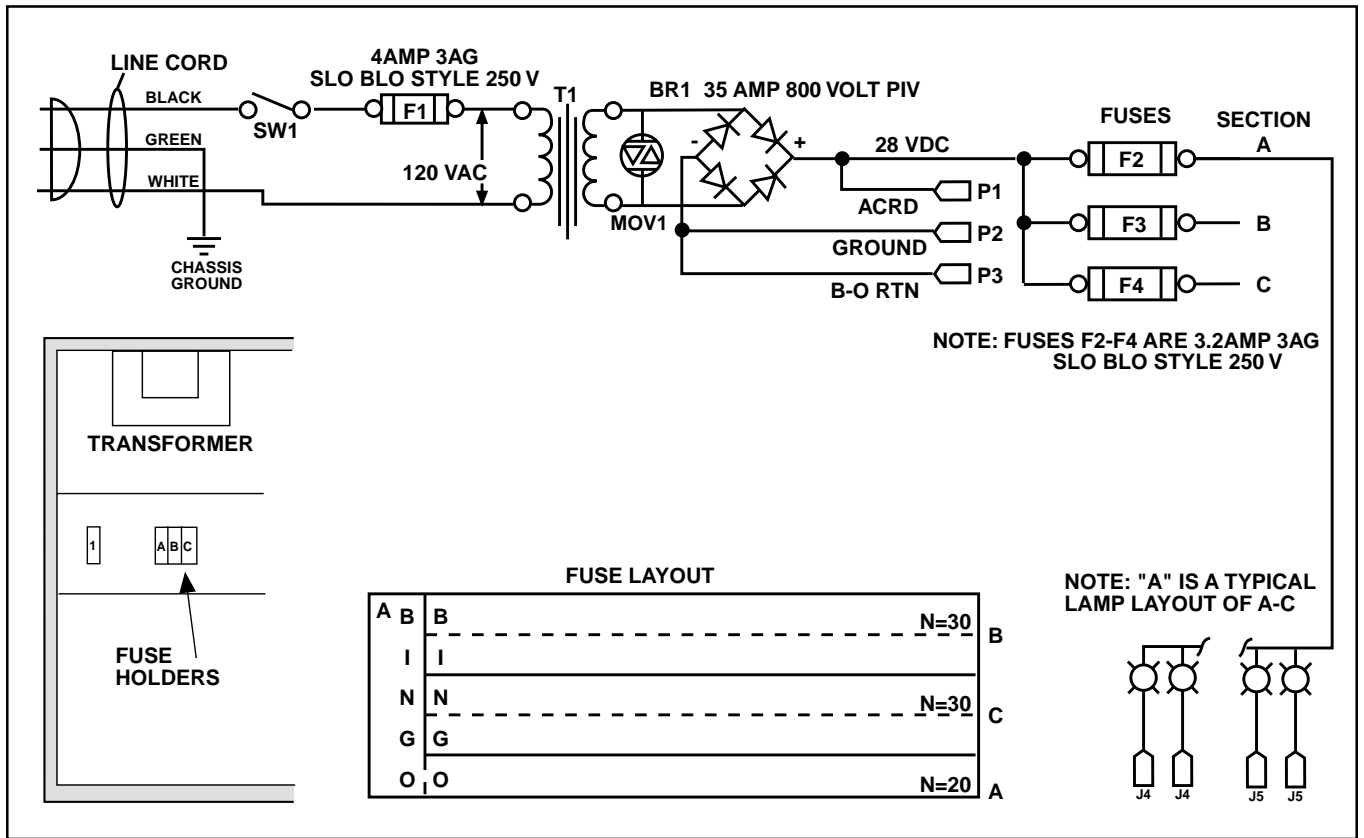

J. 4" FB Primary Wiring Schematic - Numbers Only

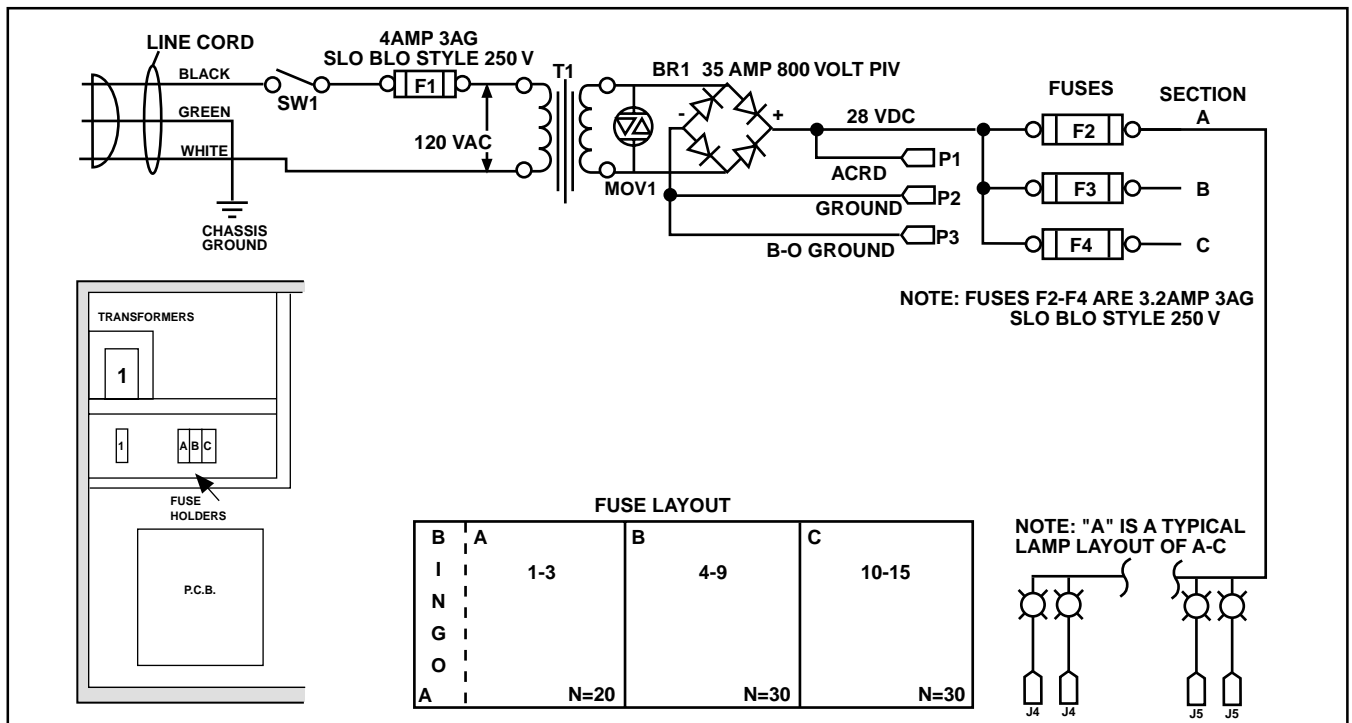

### K. 8" FB Primary Wiring Schematic - Numbers Only

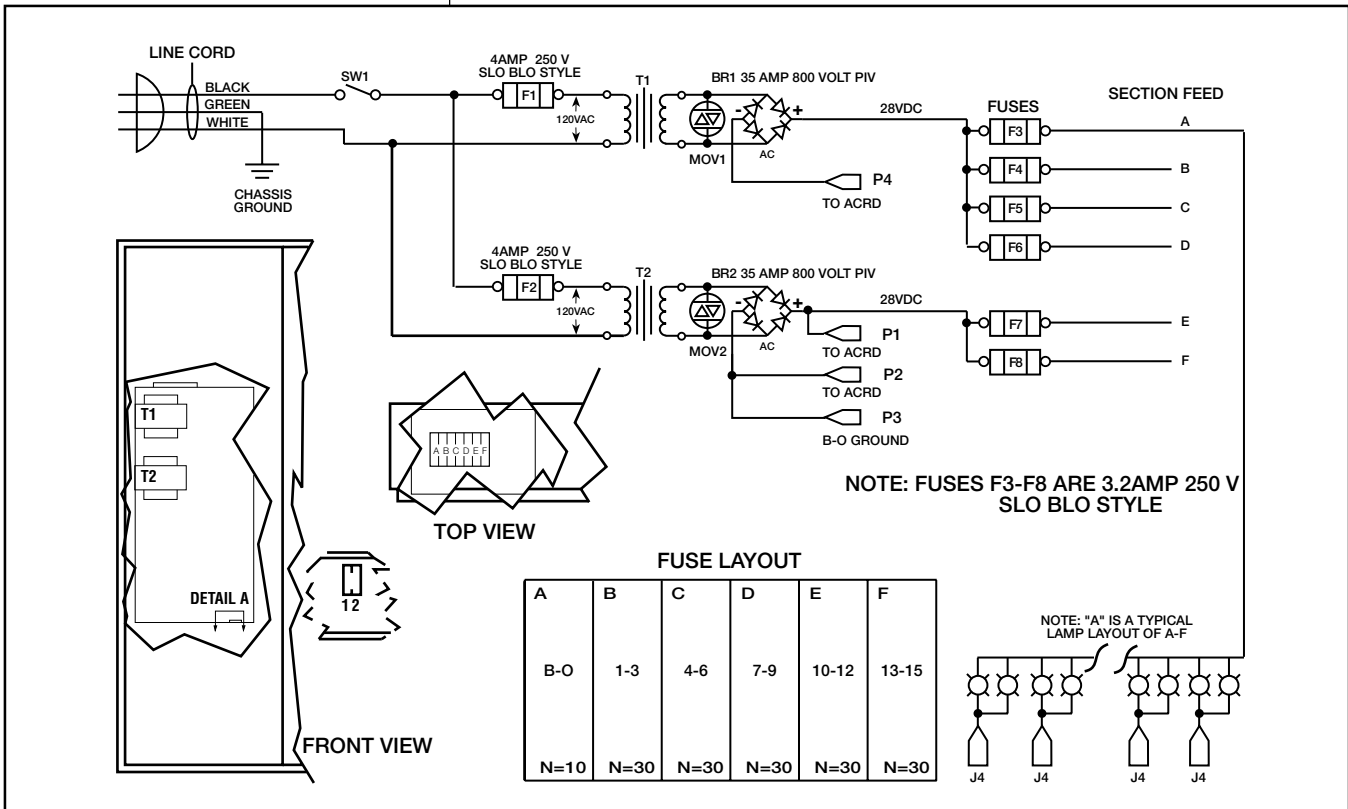

### L. 12" FB Primary Wiring Schematic - Numbers Only

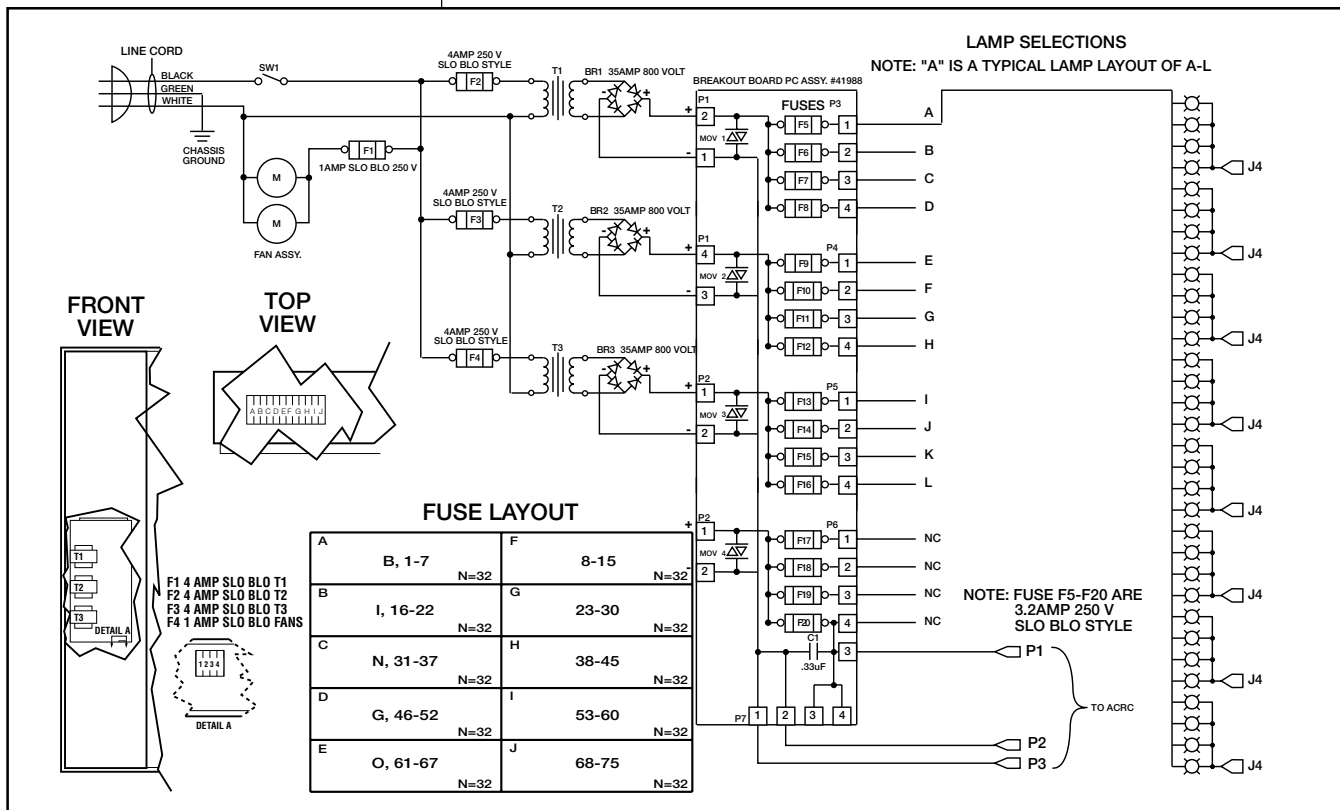

M. 2" FB Primary Wiring Schematic - Numbers and Game Indicator

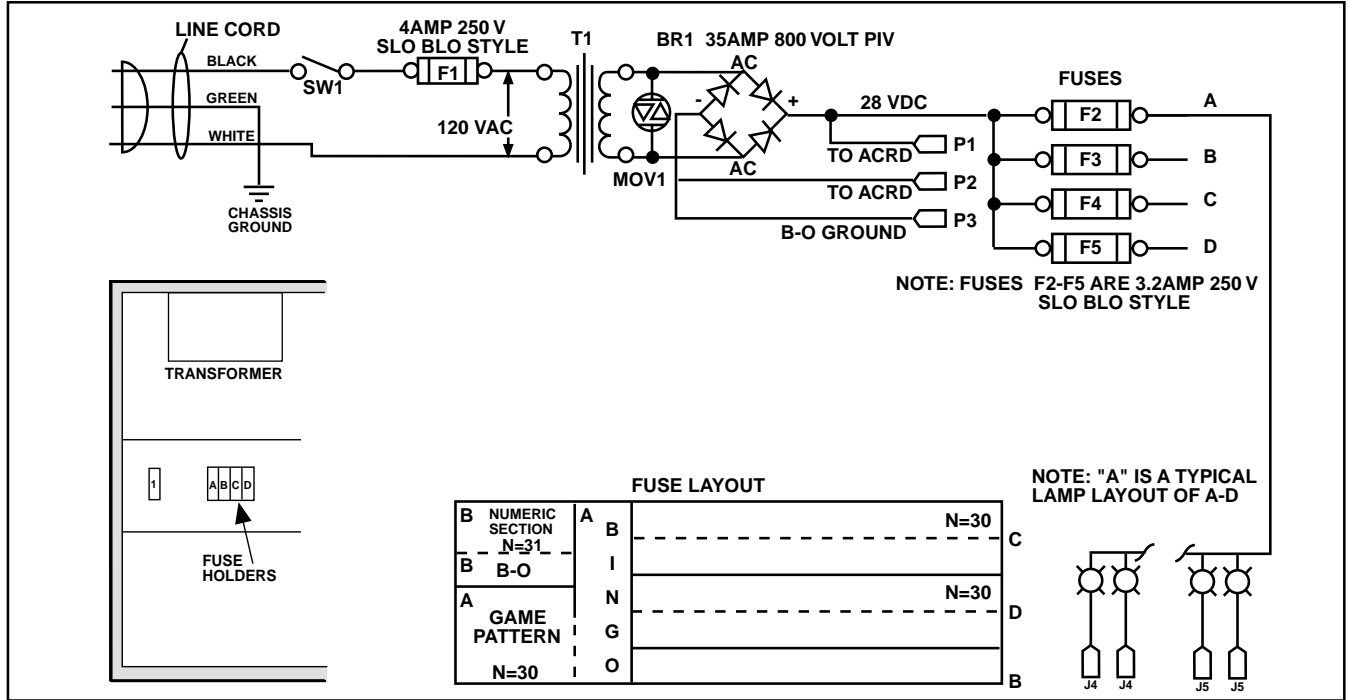

N. 4" FB Primary Wiring Schematic - Numbers and Game Indicator

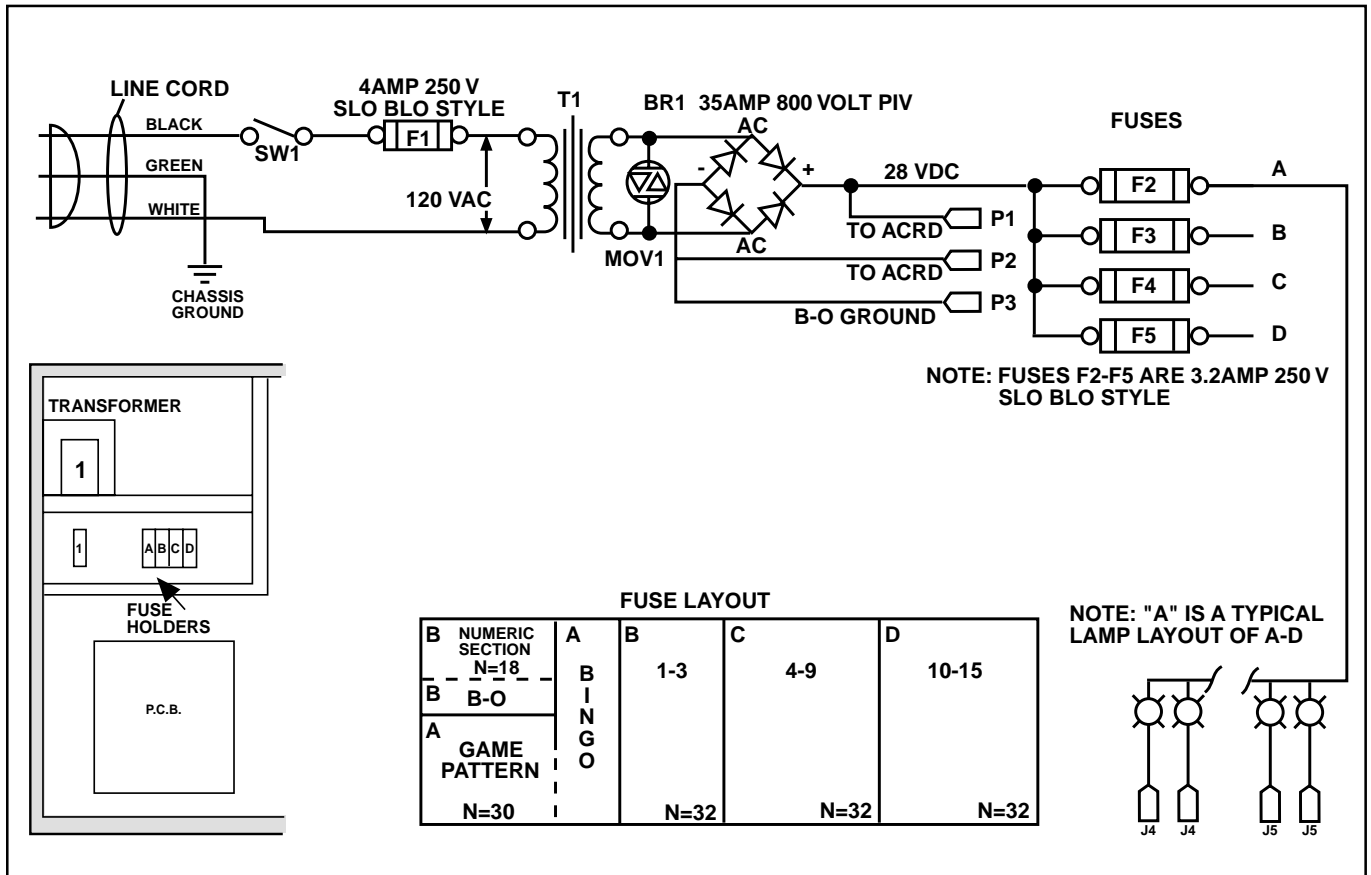

### O. 8" FB Primary Wiring Schematic - Numbers and Game Indicator

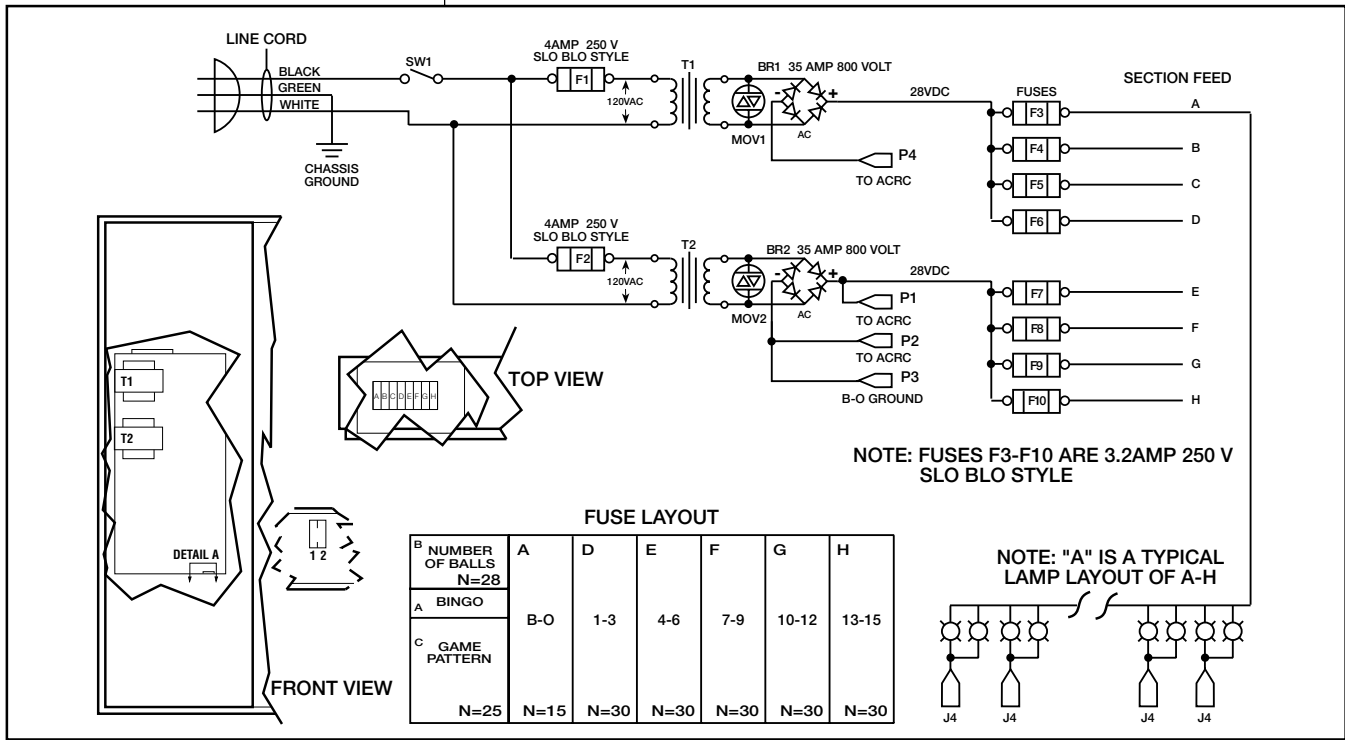

### P. 12" FB Primary Wiring Schematic - Numbers and Game Indicator

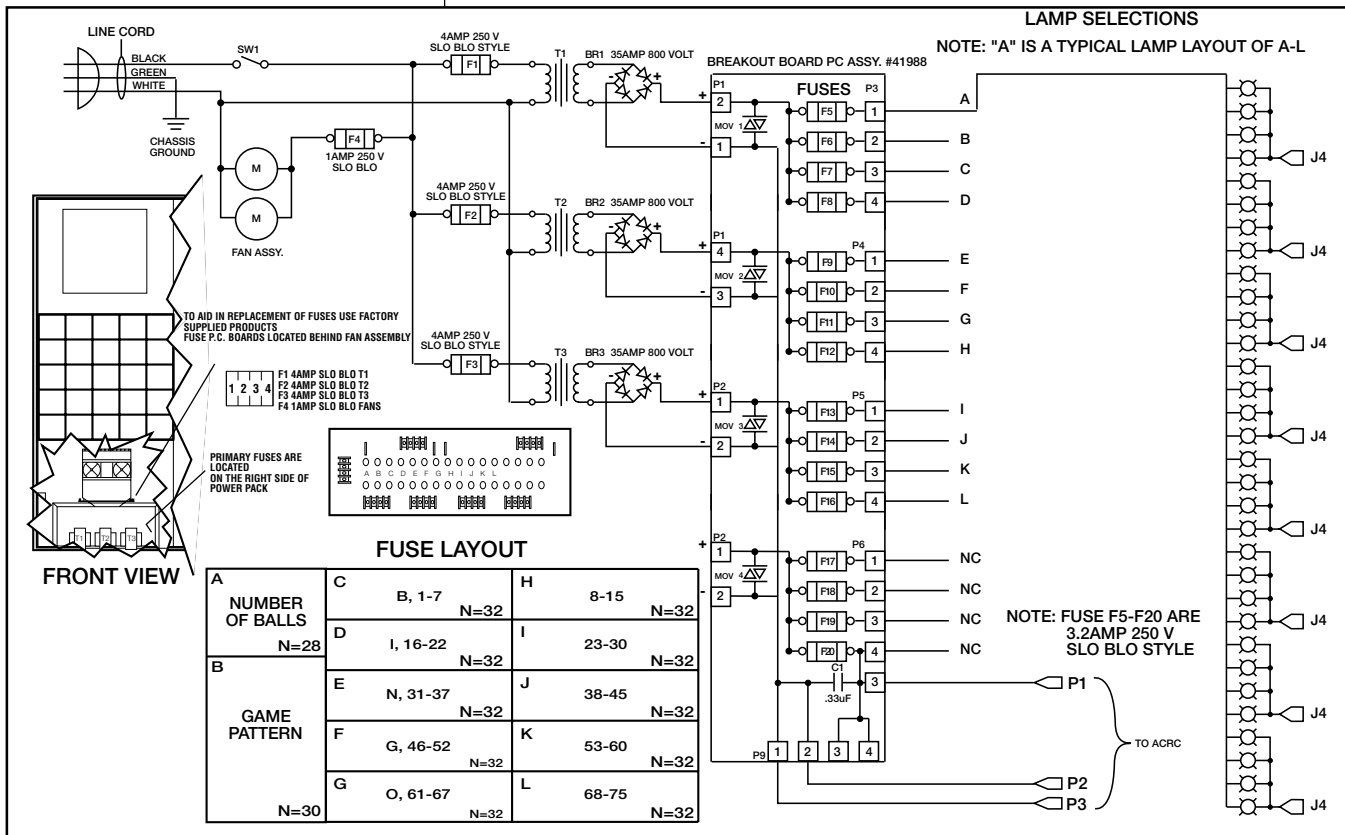

**Q. 2" FB Primary Wiring Schematic - Numbers, Game Indicator & Dollar Value**

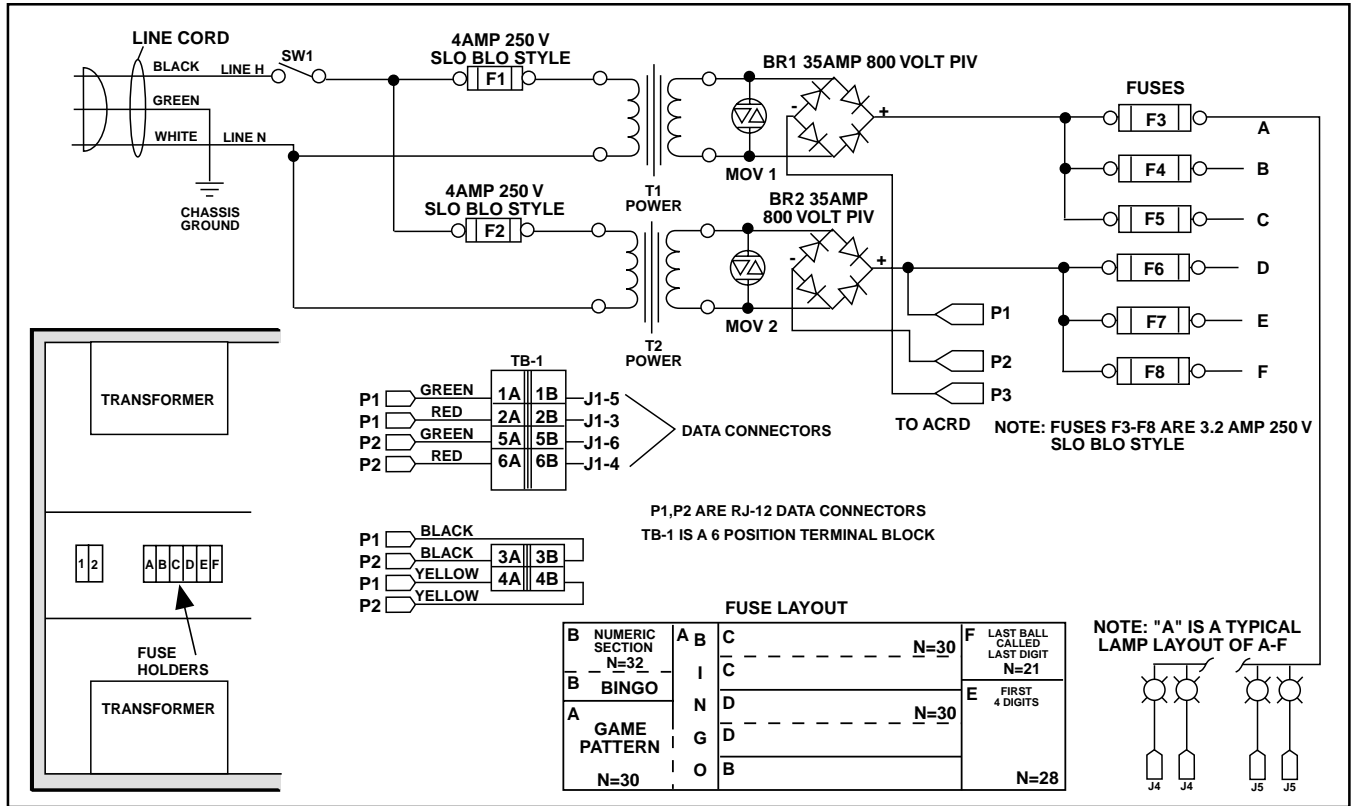

**R. 4" FB Primary Wiring Schematic - Number, Game Indicator & Dollar Value**

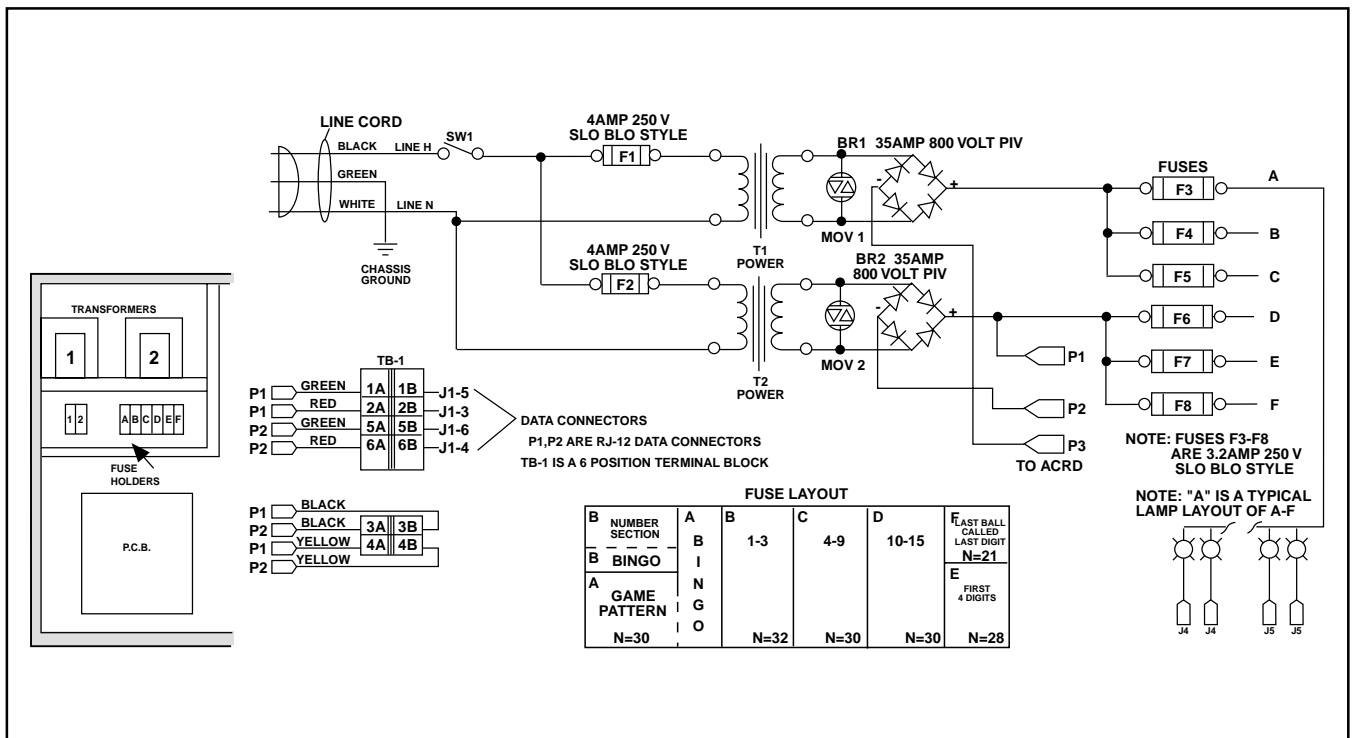

### S. 8" FB Primary Wiring Schematic - Numbers, Game Indicator & Dollar Value

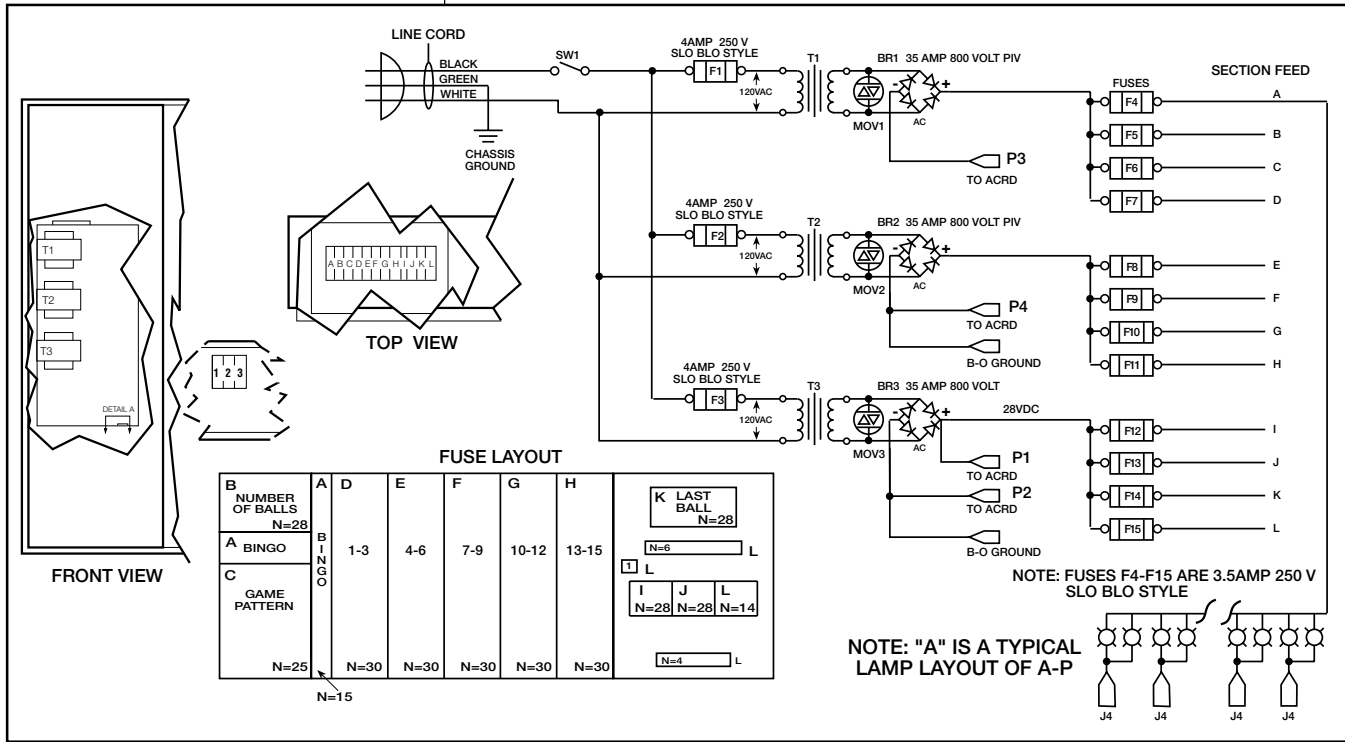

### T. 12" FB Primary Wiring Schematic - Numbers, Game Indicator & Dollar Value

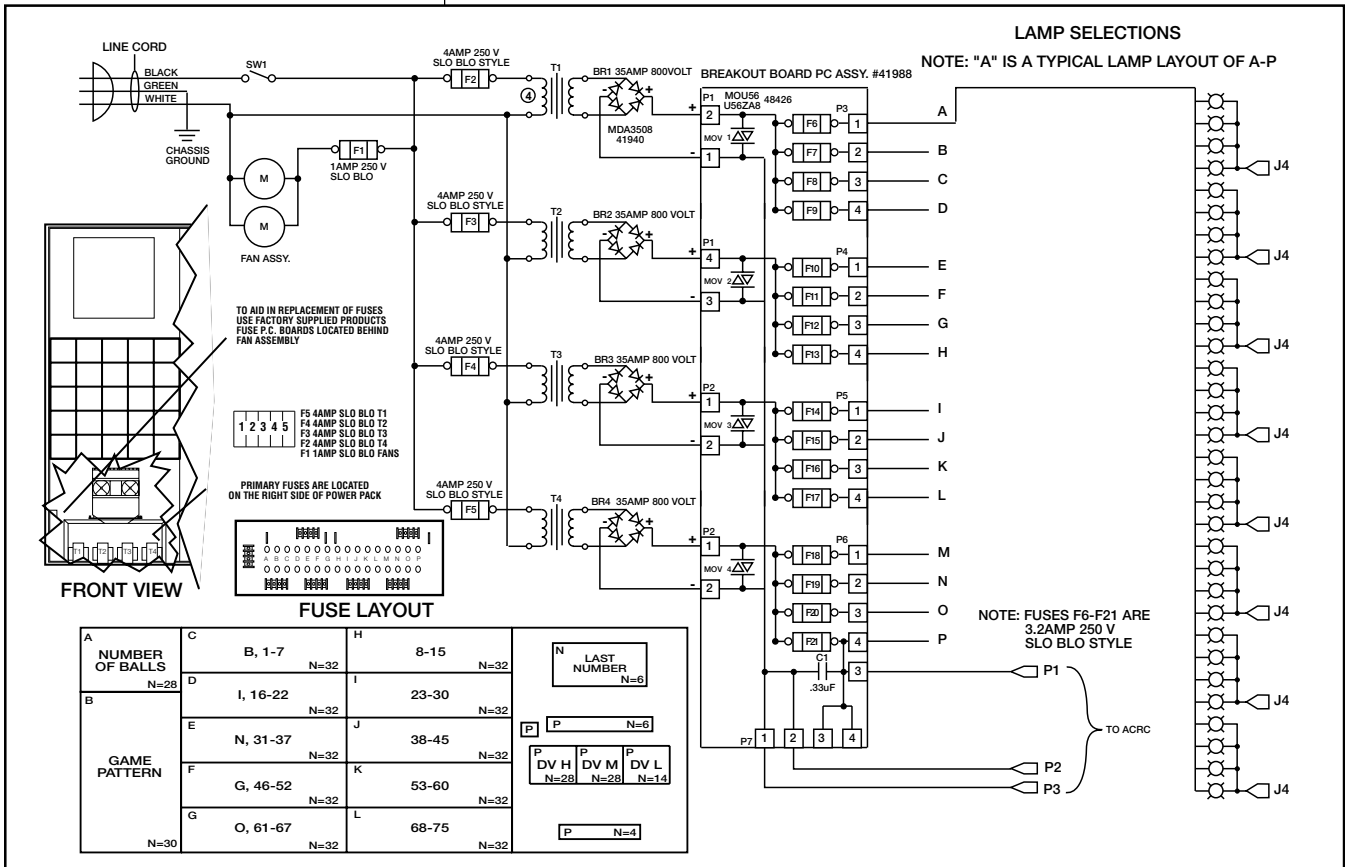

---

# Capitol Bingo Equipment Limited Warranty

---

Set out below are the terms of the Limited Warranty made by Arrow International, Inc. ("Arrow") in connection with the sale of the Capitol Bingo Equipment (the "Equipment").

## 1. Limited Warranty

Arrow warrants to the original purchaser ("Purchaser") that the Equipment will, for a period of TWO YEAR from the date of original purchase of any equipment in the "Statesman" product line from an authorized Arrow dealer, be free from manufacturing defects in material and workmanship. Purchaser represents to Arrow that no employee, agent, or representative of Arrow (or of an Arrow dealer) has made any representation or warranty regarding the Equipment except as set out herein.

THE WARRANTY CARD MUST BE COMPLETED AND RETURNED TO ARROW WITHIN 30 DAYS OF PURCHASE FROM AN AUTHORIZED CAPITOL BINGO EQUIPMENT DISTRIBUTOR FOR THIS LIMITED WARRANTY TO BE EFFECTIVE. A purchase receipt or other proof of date of original purchase must be submitted with the Warranty Card and will be required before warranty service is rendered.

This Limited Warranty applies to normal commercial use and does not cover damage which occurs in shipment; failures which are caused by products not supplied by Arrow, failures which result from accident, misuse, abuse, neglect, mishandling, misapplication, alteration, set-up adjustments or modifications. This Limited Warranty does not cover any damage to the Equipment resulting from failure to install in strict conformity with both local fire and building codes and regulations, or if installation does not comply with the installation instructions provided by Arrow.

## 2. Disclaimer of Warranties

Arrow makes no warranties, express or implied (including, without limitation, merchantability, fitness for particular purpose, or against infringement of any patent), except as expressly provided herein. The express warranties provided herein are in lieu of and exclude all other warranties, guarantees or representations, express or implied, whether arising by operation of law or otherwise.

## 3. Limitation of Remedies

If the Equipment supplied does not conform to the Limited Warranty set out above, Arrow will, at its option, (a) repair or replace the Equipment, or part thereof, which is defective or (b) refund so much of the purchase price as Purchaser has paid for the defective Equipment, less 1/24th of the purchase price for each month between the date of the purchase from an authorized Arrow dealer and the date of the discovery of the defect, provided that written notice of the defect and its nature is given to Arrow as soon as practical after discovery of the defect, but in no event later than 90 days from the date of the discovery of the defect.

## 4. Limitation of Liability

The remedy of repair, replacement, or refund of the purchase price is Purchaser's sole and exclusive remedy and will satisfy all of Arrow's liabilities, whether based on contract, negligence, tort, product liability, strict liability, or otherwise. IN NO EVENT WILL ARROW BE LIABLE FOR INCIDENTAL OR CONSEQUENTIAL DAMAGES, NOR WILL ITS INABILITY IN CONNECTION WITH ANY EQUIPMENT OR SERVICE SOLD (INCLUDING NONDELIVERY OR LATE DELIVERY THEREOF) EXCEED THE SALES PRICE OF SUCH EQUIPMENT OR SERVICE.

## 5. Warranty Voided

Any obligations of Arrow under this Limited Warranty will be deemed to have been satisfied if anyone other than an authorized Capitol Bingo Equipment Dealer services the Equipment.

## 6. Transfer of Limited Warranty

Purchaser may transfer its rights under this Limited Warranty, subject to the terms and conditions hereof, to a buyer ("Buyer") from Purchaser of the Equipment. Thereafter, the rights under this Limited Warranty are not transferable. For the transfer by Purchaser of the Limited Warranty to be effective, the following conditions must have occurred no later than the 30th day following the date of resale to Buyer:

- A. Purchaser must have complied with all requirements to make the Limited Warranty effective as to Purchaser;
- B. The Equipment (as an entire unit and as purchased by Purchaser) must be transferred to Buyer; and
- C. Buyer must have submitted a new warranty card together with proof of purchase by Buyer from Purchaser.

Upon an effective transfer of this Limited Warranty, Buyer will be considered to be "Purchaser" for paragraphs 1 and 4 hereof.

## 7. Inspection

With respect to any claim that the Equipment is defective, Arrow will be allowed a reasonable time to inspect the Equipment, in place. If the Equipment is altered or removed before Arrow has made such inspection or waived its right to do so, the obligations of Arrow will be deemed to have been satisfied.

## 8. Limitation of Actions

Any legal action against Arrow for a default of its obligations under this Limited Warranty must be commenced within two years from the date the Equipment was sold by an authorized dealer of the Equipment.

## 9. How to Obtain Service

If a problem with this Equipment develops during or after the warranted as follows:

- A. Refer to your Operator's Manual and follow the Troubleshooting Table within the "Service Section."
- B. Contact the authorized Capitol Bingo Equipment Distributor from whom you purchased the Equipment.
- C. Contact the Capitol Bingo Equipment Service Manager at the most convenient phone number listed below:

1 (800) 321-0757 outside Ohio, but within the U.S.A.  
1 (800) 537-3479 within the state of Ohio  
1 (216) 961-3500 within the 216 area code or  
outside the continental U.S.A.  
1 (216) 961-3641 fax number in Cleveland, Ohio

SERVICE CALLS WHICH DO NOT INVOLVE DEFECTIVE MATERIALS OR WORKMANSHIP AS DETERMINED BY ARROW IN ITS SOLE DISCRETION, ARE NOT COVERED. COST OF SUCH SERVICE CALLS ARE THE RESPONSIBILITY OF THE PURCHASER.

Arrow wants you to remain a satisfied customer. If a problem occurs that cannot be resolved to your satisfaction, please contact us immediately. Phone one of the numbers listed above or write to:

Capitol Bingo Equipment Division  
c/o National Service Manager  
9900 Clinton Rd.  
Cleveland, Ohio 44144

Please be sure to include the name, model number, serial number, date of original purchase, and the distributor from whom you purchased the Equipment, as well as any actions taken to correct the problem.

# WARNING:

**You must complete and return the enclosed warranty card immediately in order to insure proper warranty coverage.**

This manual was accurate at the time of printing. Arrow International reserves the right to make changes due to changing technology and regulations. Please consult your distributor or Arrow International Inc.

SAMPLE CUSTOMER WARRANTY CARD		SAMPLE
CAPITOL BINGO EQUIPMENT OWNER REGISTRATION CARD		
Model No _____	PCB No(s) _____	
Serial No. _____	Date Purchased _____	
Distributor Purchased From _____		
Name of Organization _____		
Address _____	Phone ( ) _____	
City _____	State _____	Zip _____
Chairman _____		
Address _____	Phone ( ) _____	
City _____	State _____	Zip _____
Additional Information (Optional)	<u>ATTACH PROOF OF PURCHASE DATE</u>	
Purchase Price _____	Average Attendance _____	
No. Of Night Games Played _____		
Time Games Played _____	Average Spending Per Person _____	

## ARROW INTERNATIONAL, INC.

and our subsidiaries

CAPITAL GAME MANUFACTURING

METRO GAME MANUFACTURING

9900 Clinton Rd., Cleveland, Ohio 44144

1 (800) 321-0757 outside Ohio, but within the U.S.A.

1 (800) 537-3479 within the state of Ohio

1 (216) 961-3500 within the 216 area code or outside the continental U.S.A.

1 (216) 961-3641 FAX

© 2002 Capitol Bingo Equipment Division of Arrow International, Inc.

